

Individual mounting

Inline	Sub-base non plug-in
--------	----------------------

Series

33

34

36

32

**37**

38

52

67

69

44

46

46

42

42

47

48P

48

48

48

400

92

92

92

93

93

ISO 01

ISO 02

ISO 1

ISO 2

ISO 3

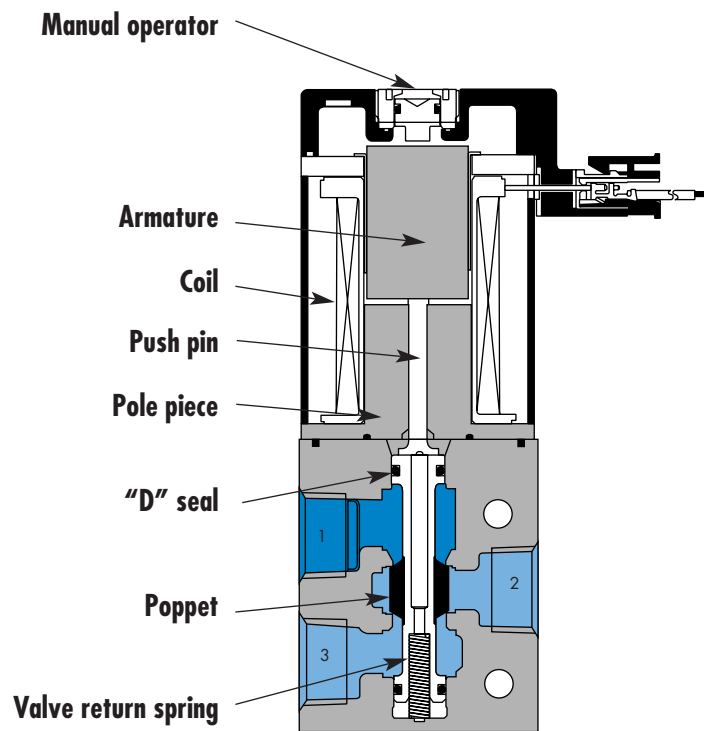

**SERIES FEATURES**

- Balanced poppet equals consistent high shifting forces.
- Valve shifting forces are consistent and independent of pressure fluctuations.
- High solenoid and return spring forces ensure high speed and precise repeatability.
- Built-in wear compensation - valve stroke is shorter than solenoid stroke.
- Constant high flow maintained throughout the pressure range.
- Exhaust contaminants are isolated from the solenoid.
- Full flow exhaust.
- Universal porting - 6 functions in one valve.

Function	Port size	Flow [Max]	Individual mounting	Series
<b>3/2 NO-NC</b>	<b>1/8" - 1/4"</b>	<b>0.5 C<sub>v</sub></b>	Inline	

### OPERATIONAL BENEFITS

- Balanced poppet equals consistent high shifting forces.
- Valve shifting forces are consistent and independent of pressure fluctuations.
- High solenoid and return spring forces ensure high speed and precise repeatability.
- Built-in wear compensation – valve stroke is shorter than solenoid stroke.
- Constant high flow maintained throughout the pressure range.
- Exhaust contaminants are isolated from the solenoid.
- Full flow exhaust.
- Universal porting – 6 functions in one valve.

### HOW TO ORDER

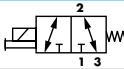
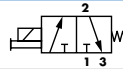
Port size	Universal valve	NC only valve
		
<b>1/8" NPTF</b>	37A-AA0-H <b>XXX-XXX</b>	37A-BA0-H <b>XXX-XXX</b>
<b>1/4" NPTF</b>	37A-AB0-H <b>XXX-XXX</b>	37A-BB0-H <b>XXX-XXX</b>



### SOLENOID OPERATOR ➤

H **XXX-XXX\***

XX	Voltage	X	Wire length	X	Manual operator	XX	Electrical connection**
AA	120 VAC (6.7W)	A	18"	1	Non-locking recessed	MA	Plug-in wire assembly
DA	24 VDC (5.2W)	B	24"	2	Locking recessed	MC	Plug-in wire assembly with light
DB	24 VDC (2.4W)					BA	Flying leads
DC	24 VDC (1.8W)					BC	Flying leads with light
						MT	Plug-in wire assembly with rectifier & light

Note : AC voltage requires connector with rectifier.

\* Other options available, see page 315.

33

34

36

32

**37**

38

52

67

69

44

46

42

47

48P

48

400

92

93

ISO 01

ISO 02

ISO 1

ISO 2

ISO 3

**TECHNICAL DATA**

<b>Fluid :</b>	Compressed air, vacuum, inert gases
<b>Pressure range :</b>	Vacuum to 120 PSI
<b>Lubrication :</b>	Not required, if used select a medium aniline point lubricant (between 180°F and 210°F)
<b>Filtration :</b>	40 μ
<b>Temperature range :</b>	0°F to 120°F (-18°C to +50°C)
<b>Flow :</b>	5.2 W : (0.5 C <sub>v</sub> ) – 2.4 W : (0.35 C <sub>v</sub> )
<b>Coil :</b>	Class A wire (#22 AWG x 18), continuous duty
<b>Voltage range :</b>	-15% to +10% of nominal voltage
<b>Power :</b>	5.2 W – 2.4 W
<b>Response times :</b> (with 5.2 W coil)	Energize : 16.9 ms De-energize : 6.7 ms

Options : • BSPP ports

**DIMENSIONS**

Dimensions shown are metric (mm)

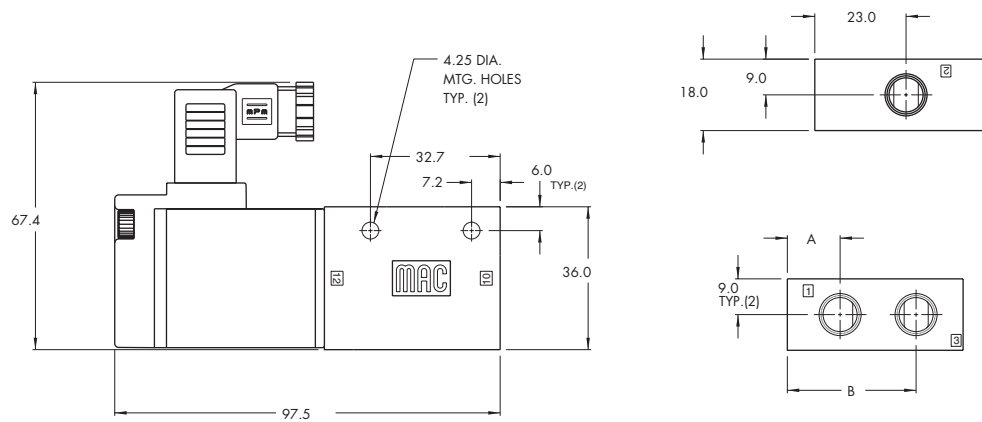

Shown with Mini Square Connector ("K" Type)

Dim	A	B
1/8"	13.3	32.45
1/4"	14.7	33.7

Function	Port size	Flow [Max]	Individual mounting	Series
<b>3/2 NO-NC</b>	<b>1/8" - 1/4"</b>	<b>0.5 C<sub>v</sub></b>	Sub-base non plug-in	

### OPERATIONAL BENEFITS

- Balanced poppet equals consistent high shifting forces.
- Valve shifting forces are consistent and independent of pressure fluctuations.
- High solenoid and return spring forces ensure high speed and precise repeatability.
- Built-in wear compensation – valve stroke is shorter than solenoid stroke.
- Constant high flow maintained throughout the pressure range.
- Exhaust contaminants are isolated from the solenoid.
- Full flow exhaust.
- Universal porting – 6 functions in one valve.



33  
34  
36  
32  
**37**  
38  
52  
67  
69  
44  
46  
42  
47  
48P  
48  
400  
92  
93  
ISO 01  
ISO 02  
ISO 1  
ISO 2  
ISO 3

### HOW TO ORDER

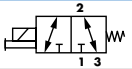
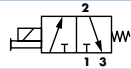
Port size	Universal valve	NC only valve
		
<b>Valve less base</b>	37A-C10-H <b>XXX-XXX</b>	37A-D10-H <b>XXX-XXX</b>
<b>1/8" NPTF</b>	37A-CAA-H <b>XXX-XXX</b>	37A-DAA-H <b>XXX-XXX</b>
<b>1/4" NPTF</b>	37A-CBA-H <b>XXX-XXX</b>	37A-DBA-H <b>XXX-XXX</b>

### SOLENOID OPERATOR >

H **XXX-XXX\***

XX	Voltage	X	Wire length	X	Manual operator	XX	Electrical connection
AA	120 VAC (6.7W)	A	18"	1	Non-locking recessed	MA	Plug-in wire assembly
DA	24 VDC (5.2W)	B	24"	2	Locking recessed	MC	Plug-in wire assembly with light
DB	24 VDC (2.4W)					BA	Flying leads
DC	24 VDC (1.8W)					BC	Flying leads with light
						MT	Plug-in wire assembly with rectifier & light

Note : AC voltage requires connector with rectifier.  
\* Other options available, see page 315.

### OPTIONS

Base only :

37A-OAA (1/8")
37A-OBA (1/4")

**TECHNICAL DATA**

<b>Fluid :</b>	Compressed air, vacuum, inert gases
<b>Pressure range :</b>	Vacuum to 120 PSI
<b>Lubrication :</b>	Not required, if used select a medium aniline point lubricant (between 180°F and 210°F)
<b>Filtration :</b>	40 μ
<b>Temperature range :</b>	0°F to 120°F (-18°C to +50°C)
<b>Flow :</b>	5.2 W : (0.5 C <sub>v</sub> ) – 2.4 W : (0.35 C <sub>v</sub> )
<b>Coil :</b>	Class A wire (#22 AWG x 18), continuous duty
<b>Voltage range :</b>	-15% to +10% of nominal voltage
<b>Power :</b>	5.2 W – 2.4 W
<b>Response times :</b> (with 5.2 W coil)	Energize : 16.9 ms De-energize : 6.7 ms

Options : • BSPP ports • Sandwich regulator - see "Regulator" Section

**DIMENSIONS**

Dimensions shown are metric (mm)

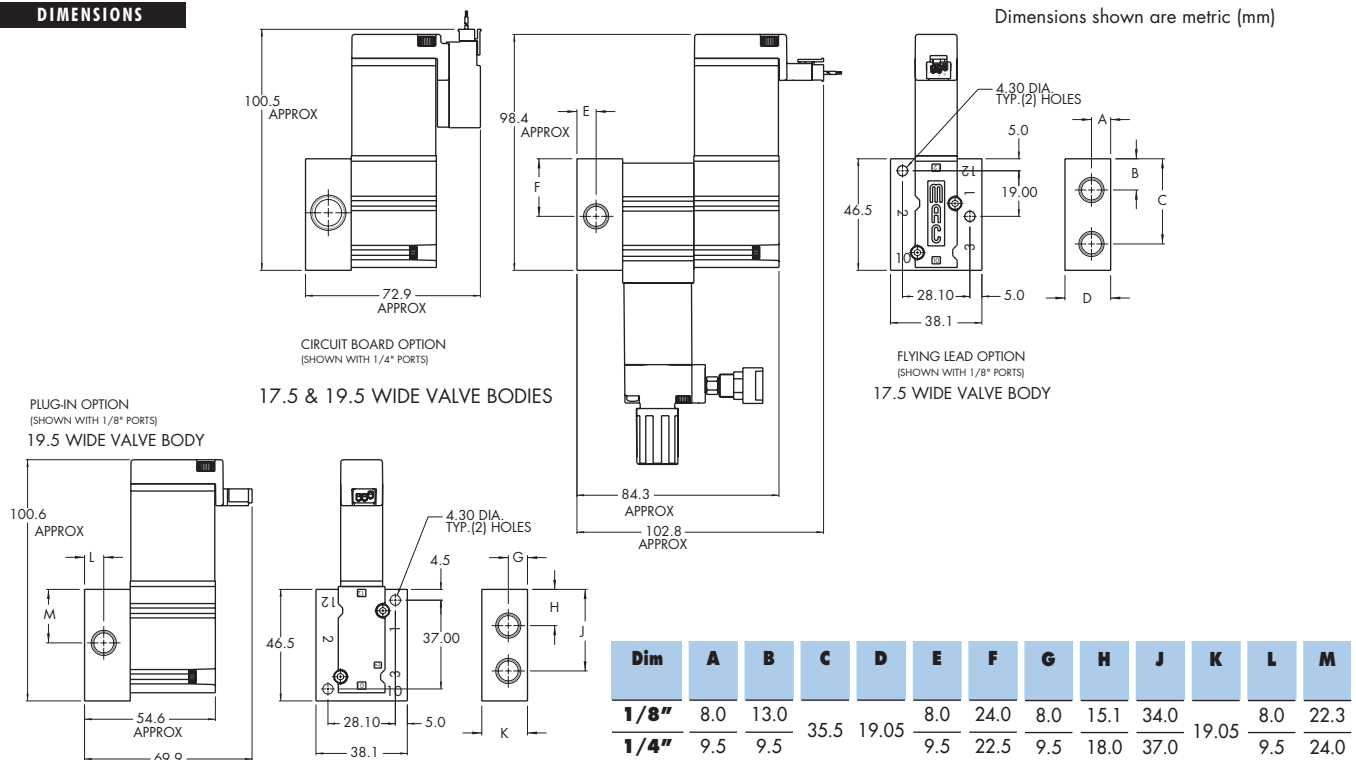



---

**Codification table for voltages / Manual operators / Electrical connections**

---

VALVE CODE > **H XX X-X XX**  
**1 2 3 4**

**OPTIONS AVAILABLE FOR**

- Solenoid valves 37 & 47 Series

---

### 1. VOLTAGE

H-XX X-X XX	VOLTAGE
<b>AA</b>	120/50, 120/60 (6.7 W) (use connector with rectifier)
<b>AB</b>	220/50, 220/60 (5.6 W) (use connector with rectifier)
<b>AC</b>	240/50, 240/60 (5.8 W) (use connector with rectifier)
<b>AD</b>	24/50, 24/60 (7.8 W) (use connector with rectifier)
<b>DA</b>	24 VDC (5.2 W)
<b>DB</b>	24 VDC (2.4 W)
<b>DC</b>	24 VDC (1.8 W)
<b>DD</b>	24 VDC (1.0 W)
<b>DF</b>	12 VDC (5.2 W)
<b>DG</b>	12 VDC (2.4 W)
<b>DH</b>	12 VDC (1.8 W)
<b>DJ</b>	12 VDC (1.0 W)
<b>DL</b>	120 VDC (6.3 W)

### 2. WIRE LENGTH

H-XX X-X XX	WIRE LENGTH
<b>0</b>	No lead wire (use with "MJ, MM & K Type connectors)
<b>A</b>	18"
<b>B</b>	24"
<b>C</b>	36"
<b>D</b>	48"
<b>E</b>	72"
<b>F</b>	96"
<b>G</b>	120"
<b>H</b>	144"

### 3. MANUAL OPERATOR

H-XX X-X XX	MANUAL OPERATOR
<b>0</b>	No operator
<b>1</b>	Non-locking recessed
<b>2</b>	Locking recessed
<b>3</b>	Non-locking extended
<b>4</b>	Locking extended

### 4. ELECTRICAL CONNECTION

H-XX X-X XX	ELECTRICAL CONNECTION
<b>BA</b>	Flying leads
<b>BB</b>	BA with ground wire
<b>BC</b>	BA with light
<b>BD</b>	BA with light & ground wire
<b>BE</b>	BA with suppression diode
<b>BF</b>	BA with suppression diode & ground wire
<b>BG</b>	BA with suppression diode plus light
<b>BH</b>	BA with suppression diode plus light & ground wire
<b>*BN</b>	BA with suppression diode plus blocking diode
<b>*BP</b>	BA with suppression diode plus blocking diode & ground wire
<b>*BR</b>	BA with suppression diode plus blocking diode & light
<b>*BS</b>	BBA with suppression diode plus blocking diode & light & ground wire
<b>BK</b>	BA with full wave rectifier

H-XX X-X XX	
<b>BL</b>	BA with full wave rectifier & ground wire
<b>BT</b>	BA with full wave rectifier plus light
<b>BU</b>	BA with full wave rectifier plus light & ground wire

H-XX X-X XX	PLUG-IN CONNECTOR
<b>FA</b>	Base plug-in
<b>FB</b>	FA with ground wire
<b>FC</b>	FA with light
<b>FD</b>	FA with light & ground wire
<b>FE</b>	FA with suppression diode
<b>FF</b>	FA with suppression diode & ground wire
<b>FG</b>	FA with suppression diode & light
<b>FH</b>	FA with suppression diode plus light & ground wire
<b>FK</b>	FA with full wave rectifier
<b>FL</b>	FA with full wave rectifier & ground wire
<b>*FN</b>	FA with suppression diode plus blocking diode
<b>*FP</b>	FA with suppression diode plus blocking diode & ground wire
<b>*FR</b>	FA with suppression diode plus blocking diode plus light
<b>*FS</b>	FA with suppression diode plus blocking diode & light & ground wire
<b>FT</b>	FA with full wave rectifier plus light
<b>FU</b>	FA with full wave rectifier plus light & ground wire
<b>MA</b>	Solenoid plug-in wire assembly
<b>MB</b>	MA with ground wire
<b>MC</b>	MA with light
<b>MD</b>	MA with light & ground wire
<b>ME</b>	MA with suppression diode
<b>MF</b>	MA with suppression diode & ground wire
<b>MG</b>	MA with suppression diode plus light
<b>MH</b>	MA with suppression diode plus light & ground wire
<b>MK</b>	MA with full wave rectifier
<b>ML</b>	MA with full wave rectifier & ground wire
<b>*MN</b>	MA with suppression diode plus blocking diode
<b>*MP</b>	MA with suppression diode plus blocking diode & ground wire
<b>*MR</b>	MA with suppression diode plus blocking diode & light
<b>*MS</b>	MA with suppression diode plus blocking diode & light & ground wire
<b>MT</b>	MA with full wave rectifier plus light
<b>MU</b>	MA with full wave rectifier plus light & ground wire
<b>MJ</b>	Plug-in housing without wire assembly ('MA' option without wire assembly)
<b>MM</b>	Plug-in housing without wire assembly ('MB' option without wire assembly)
<b>KA</b>	Mini square connector
<b>KB</b>	KA with suppression diode
<b>KC</b>	KA with M.O.V.
<b>KD</b>	KA with light
<b>KE</b>	KA with light & suppression diode
<b>KF</b>	KA with light & M.O.V.
<b>KJ</b>	Mini square connector – male only
<b>KK</b>	KJ with suppression diode
<b>KL</b>	KJ with M.O.V.
<b>KM</b>	KA with full wave rectifier
<b>KN</b>	KA with full wave rectifier & M.O.V.
<b>KP</b>	KA with full wave rectifier & light
<b>KR</b>	KA with full wave rectifier plus light & M.O.V.
<b>KS</b>	KJ with full wave rectifier

\* Blocking diode is located in the lead wire