

Individual mounting

inline	sub-base non "plug-in"
--------	------------------------

Series

Manifold mounting

stacking	sub-base non "plug-in"	sub-base with pressure regulators	sub-base with pressure regulators and flow controls
----------	------------------------	-----------------------------------	---

35

100

200

55

56

57

58

59

45

700

900

82

6300

6500

6600

1300

800

ISO 1

ISO 2

ISO 3

MAC 125A

MAC 250A

MAC 500A

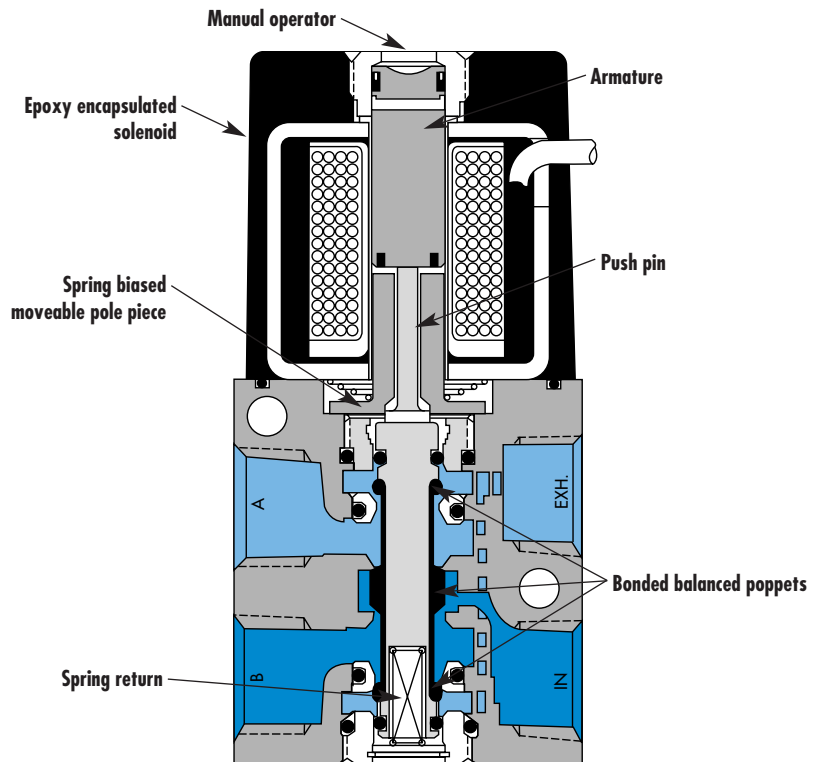

**SERIES FEATURES**

- Single and double solenoid or remote air.
- The patented MACSOLENOID® for fastest possible response times.
- Bonded balanced poppets for high flow, precise repeatability, and consistent operation.
- Balanced poppet design permits versatility in piping. Valves can be piped as 4-way, 3-way or 2-way, normally closed or normally open or can be used for vacuum, diverter or selector applications.
- Use on lube or non-lube service.
- Extremely high cycle rates.
- Extremely long service life due to unique poppet cushions.
- Manual overrides as standard.
- Various solenoid enclosures and plug-in connectors
- Optional surge suppression available.
- Low wattage DC solenoids — down to 1.8 watts.
- Patented MACSOLENOID® — virtually burn-out proof on AC service.

**VALVE CONFIGURATIONS AVAILABLE**

- 2-position single and double solenoid or remote air.
- Single pressure (4 or 5 ports)
- Individual, stacking and manifold base mounted models.
- Integral individual exhaust flow controls with common exhaust port.
- Integral regulators and flow controls on manifolds.

**SPECIAL APPLICATIONS :**

The balanced poppet design facilitates using the same valve for many functions and can be used for pressure, vacuum or plugged without the necessity of changing any parts.

Piping suggestions are shown in the chart below.

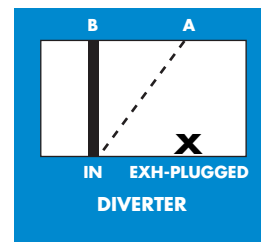
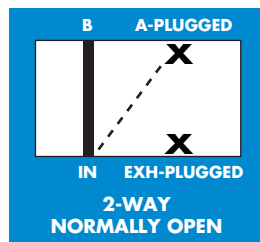
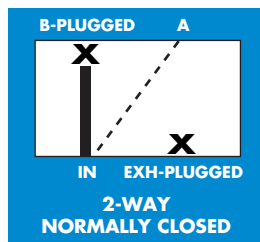
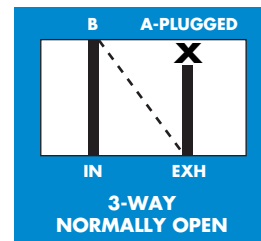
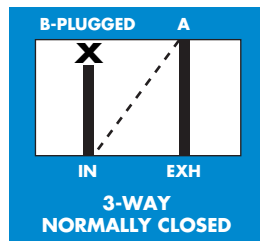
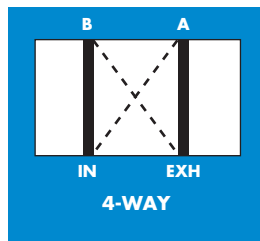

Operator De-Energized ———

Operator Energized - - - - -

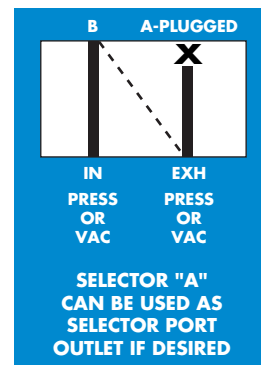



# Direct solenoid and solenoid pilot operated valves

Function	Port size	Flow [Max]	Individual mounting	Series
<b>4/2</b>	<b>#10-32 - 1/8"</b>	<b>0.15 C<sub>v</sub></b>	inline	

### OPERATIONAL BENEFITS

1. Balanced poppet, immune to variations of pressure.
2. Short stroke with high flow.
3. The patented solenoid develops high shifting forces.
4. Powerful return spring.
5. Manual operator standard on all valves.
6. Burn-out proof solenoid on AC service.



35  
100  
200  
55  
56  
57  
58  
59

### HOW TO ORDER

Port size	Single operator	Double operator (Minimum DC wattage 5.4W)
<b>1/8" NPTF</b>	45A-AA1-DXXX-XXX	45A-GA1-DXXX-XXX
<b># 10-32 UNF</b>	45A-AB1-DXXX-XXX	45A-GB1-DXXX-XXX

45

### WITH INTEGRATED FLOW CONTROLS

Port size	Single operator	Double operator (Minimum DC wattage 5.4W)
<b>1/8" NPTF</b>	45A-AA2-DXXX-XXX	45A-GA2-DXXX-XXX
<b># 10-32 UNF</b>	45A-AB2-DXXX-XXX	45A-GB2-DXXX-XXX

700  
900  
82

### SOLENOID OPERATOR ▶

D **XX X- X XX\***

XX Voltage	X Wire length	X Manual operator	XX Electrical connection
AA 120/60, 110/50	A 18" (Flying leads)	1 Non-locking	KA Square connector
AB 240/60, 220/50	J Connector	2 Locking	KD Square connector with light
AC 24/60, 24/50			JB Rectangular connector
FB 24 VDC (1.8 W)			JD Rectangular connector with light
DA 24 VDC (5.4 W)			BA Flying leads
DF 24 VDC (12.7 W)			

6300  
6500  
6600  
1300

\* Other options available, see page 353.

### BOTTOM PORT OPTIONS (O'RING MOUNT)

45A-XXX-D xxx-xxx

- D-Sgl. oper. - All ports
- F-Sgl. oper. - "A" & "B" ports
- H-Dbl. oper. - All ports
- J-Dbl. oper. - "A" & "B" ports

800  
ISO 1  
ISO 2  
ISO 3  
MAC 125A  
MAC 250A  
MAC 500A

**TECHNICAL DATA**

<b>Fluid :</b>	Compressed air, vacuum, inert gases		
<b>Pressure range :</b>	Vacuum to 120 PSI		
<b>Lubrication :</b>	Not required, if used select a medium aniline point lubricant (between 180°F and 210°F)		
<b>Filtration :</b>	40 µ		
<b>Temperature range :</b>	0°F to 120°F (-18°C to 50°C)		
<b>Flow (at 6 bar, ΔP=1bar) :</b>	1.8 W : (0.1 C <sub>v</sub> ), 5.4 W : (0.15 C <sub>v</sub> )		
<b>Coil :</b>	General purpose class A, continuous duty, encapsulated		
<b>Voltage range :</b>	-15% to +10% of nominal voltage		
<b>Protection :</b>	Consult factory		
<b>Power :</b>	~ Inrush : 10.9 VA    Holding : 7.7 VA = 1.8 to 12.7 W		
<b>Response times :</b>	24 VDC (5.4 W)	Energize : 6 ms	De-energize : 2 ms
	120/60	Energize : 3-8 ms	De-energize : 2-7 ms

Spare parts :      • Solenoid operator (power ≥ 5.4 W) : DXXX-XXX, including mounting screws 35013.  
                           • Seal (between solenoid and valve body) : 16402. • Valve cover plate with flow controls : N-45002.

Options :            • BSPP threads. • High flow up to 0.23 C<sub>v</sub>, according to wattage and high flow Mod. • NAMUR interface - 45A-FA1DXXX-XXX and required NAMUR adapter kit: N-45028-03 (for 3-way operation) - N-45028-04 (for 4-way operation).

**DIMENSIONS**

Dimensions shown are metric (mm)

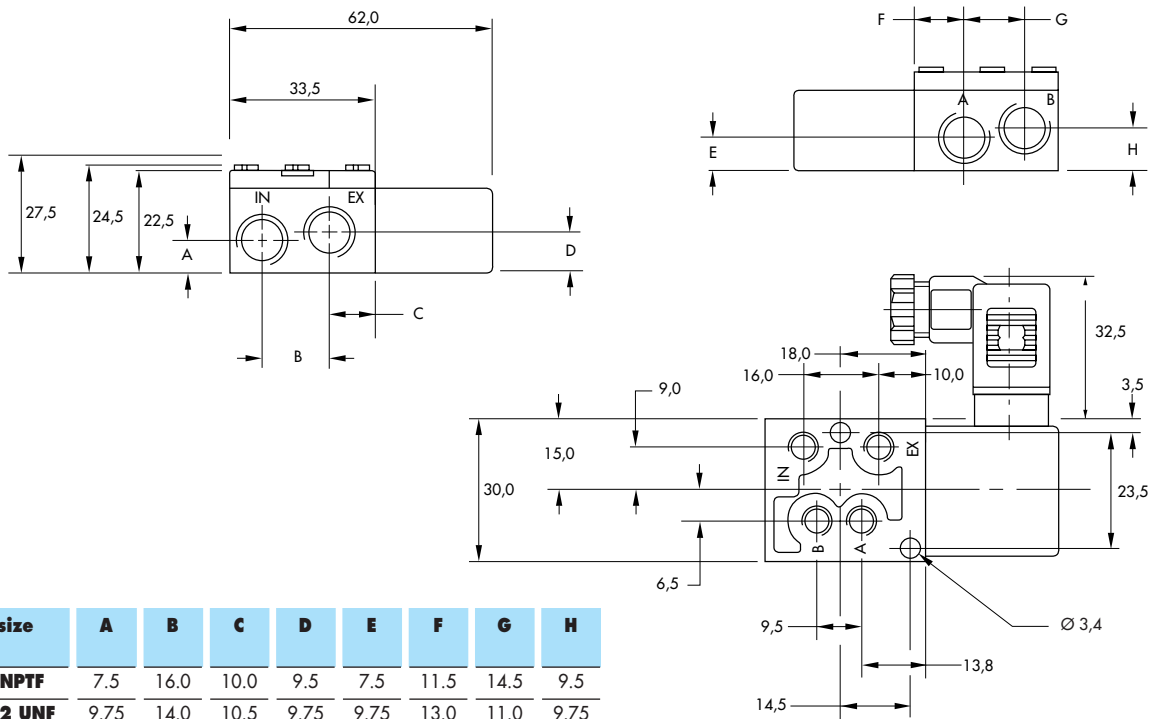



# Direct solenoid and solenoid pilot operated valves

Function	Port size	Flow (Max)	Individual mounting	Series
4/2	#10-32 - 1/8"	0.13 C <sub>v</sub>	sub-base non "plug-in"	

### OPERATIONAL BENEFITS

1. Balanced poppet, immune to variations of pressure.
2. Short stroke with high flow.
3. The patented solenoid develops high shifting forces.
4. Powerful return spring.
5. Manual operator standard on all valves.
6. Burn-out proof solenoid on AC service.



- 35
- 100
- 200
- 55
- 56
- 57
- 58
- 59

### HOW TO ORDER

Port size	Single operator	Double operator (Minimum DC wattage 5,4W)
<b>Valve less base</b>	45A-L00-Dxxx-xxx	45A-N00-Dxxx-xxx
<b>1/8" NPTF base</b>	45A-LAA-Dxxx-xxx	45A-NAA-Dxxx-xxx
<b>#10-32 UNF base</b>	45A-LBA-Dxxx-xxx	45A-NBA-Dxxx-xxx

45

### WITH INTEGRATED FLOW CONTROLS

Port size	Single operator	Double operator (Minimum DC wattage 5,4W)
<b>Valve less base</b>	45A-L00-Dxxx-xxx	45A-N00-Dxxx-xxx
<b>1/8" NPTF base</b>	45A-LAB-Dxxx-xxx	45A-NAB-Dxxx-xxx
<b>#10-32 UNF base</b>	45A-LBB-Dxxx-xxx	45A-NBB-Dxxx-xxx

- 700
- 900
- 82

### SOLENOID OPERATOR >

D **XX X- X XX\***

XX Voltage	X Wire length	X Manual operator	XX Electrical connection
AA 120/60, 110/50	A 18" (Flying leads)	1 Non-locking	KA Square connector
AB 240/60, 220/50	J Connector	2 Locking	KD Square connector with light
AC 24/60, 24/50			BA Flying leads
FB 24 VDC (1.8 W)			
DA 24 VDC (5.4 W)			
DF 24 VDC (12.7 W)			

- 6300
- 6500
- 6600
- 1300

\* Other options available, see page 353.

### OPTIONS

45A-LAA-D xxx-xxx

Substitute "J" for 1/8" bottom cylinder ports

- 800
- ISO 1
- ISO 2
- ISO 3
- MAC 125A
- MAC 250A
- MAC 500A

**TECHNICAL DATA**

<b>Fluid :</b>	Compressed air, vacuum, inert gases		
<b>Pressure range :</b>	Vacuum to 120 PSI		
<b>Lubrication :</b>	Not required, if used select a medium aniline point lubricant (between 180°F and 210°F)		
<b>Filtration :</b>	40 μ		
<b>Temperature range :</b>	0°F to 120°F (-18°C to 50°C)		
<b>Flow (at 6 bar, ΔP=1bar) :</b>	1.8 W : (0.11 C <sub>v</sub> ), 5.4 W : (0.13 C <sub>v</sub> )		
<b>Coil :</b>	General purpose class A, continuous duty, encapsulated		
<b>Voltage range :</b>	-15% to +10% of nominal voltage		
<b>Protection :</b>	Consult factory		
<b>Power :</b>	~ Inrush : 10.9 VA    Holding : 7.7 VA = 1.8 to 12.7 W		
<b>Response times :</b>	24 VDC (5.4 W)	Energize : 6 ms	De-energize : 2 ms
	120/60	Energize : 3-8 ms	De-energize : 2-7 ms

Spare parts :                    • Solenoid operator (power ≥ 5.4 W) : DXXX-XXX, including mounting screws 35013.  
    • Seal (between solenoid and valve body) : 16402. • Seal between base and valve : 16453. • Flow control : N-45018.

Options :                            • BSPP threads. • High flow up to 0.20 C<sub>v</sub>, according to wattage and high flow mod.

**DIMENSIONS**

Dimensions shown are metric (mm)

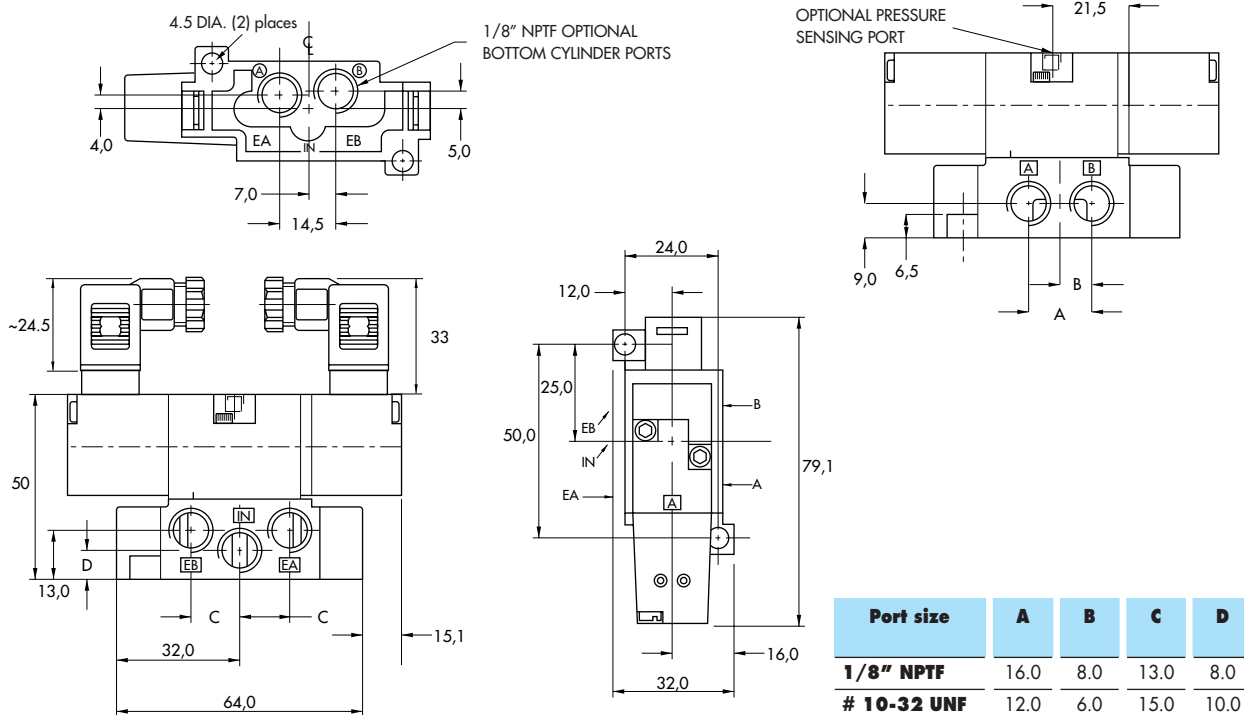



# Direct solenoid and solenoid pilot operated valves

Function	Port size	Flow [Max]	Manifold mounting	Series
<b>4/2</b>	<b># 10-32 - 1/8"</b>	<b>0.20 C<sub>v</sub></b>	stacking	

### OPERATIONAL BENEFITS

1. Balanced poppet, immune to variations of pressure.
2. Short stroke with high flow.
3. The patented solenoid develops high shifting forces.
4. Powerful return spring.
5. Manual operator standard on all valves.
6. Burn-out proof solenoid on AC service.



35  
100  
200  
55  
56  
57  
58  
59

### HOW TO ORDER

Port size	Single operator	Double operator (Minimum DC wattage 5,4W)
<b>1/8" NPTF</b>	45A-SA1-DXXX-XXX	45A-TA1-DXXX-XXX
<b># 10-32 UNF</b>	45A-SB1-DXXX-XXX	45A-TB1-DXXX-XXX

45

### WITH INTEGRATED FLOW CONTROLS

Port size	Single operator	Double operator
<b>1/8" NPTF</b>	45A-SA2-DXXX-XXX	45A-TA2-DXXX-XXX
<b># 10-32 UNF</b>	45A-SB2-DXXX-XXX	45A-TB2-DXXX-XXX

700  
900  
82

### SOLENOID OPERATOR >

D **XX X- X XX**\*

XX	Voltage	X	Wire length	X	Manual operator	XX	Electrical connection
AA	120/60, 110/50	A	18" (Flying leads)	1	Non-locking	KA	Square connector
AB	240/60, 220/50	J	Connector	2	Locking	KD	Square connector with light
AC	24/60, 24/50					BA	Flying leads
FB	24 VDC (1.8 W)						
DA	24 VDC (5.4 W)						
DF	24 VDC (12.7 W)						

6300  
6500  
6600

\* Other options available, see page 353.

End plate kit required (Port size 1/4" NPTF) : M-45001-01.

1300  
800  
ISO 1  
ISO 2  
ISO 3  
MAC 125A  
MAC 250A  
MAC 500A

**TECHNICAL DATA**

<b>Fluid :</b>	Compressed air, vacuum, inert gases		
<b>Pressure range :</b>	Vacuum to 120 PSI		
<b>Lubrication :</b>	Not required, if used select a medium aniline point lubricant (between 180°F and 210°F)		
<b>Filtration :</b>	40 µ		
<b>Temperature range :</b>	0°F to 120°F (-18°C to 50°C)		
<b>Flow (at 6 bar, ΔP=1bar) :</b>	1.8 W : (0.14 C <sub>v</sub> ), 5.4 W : (0.2 C <sub>v</sub> )		
<b>Coil :</b>	General purpose class A, continuous duty, encapsulated		
<b>Voltage range :</b>	-15% to +10% of nominal voltage		
<b>Protection :</b>	Consult factory		
<b>Power :</b>	~ Inrush : 10.9 VA    Holding : 7.7 VA = 1.8 to 12.7 W		
<b>Response times :</b>	24 VDC (5.4 W)	Energize : 6 ms	De-energize : 2 ms
	120/60	Energize : 3-8 ms	De-energize : 2-7 ms

Spare parts :

- Solenoid operator (power ≥ 5.4 W) : DXXX-XXX, including mounting screws 35013.
- Seal (between solenoid and valve body) : 16402. • Seal between valves : 16422. • Tie-rod (x2) : 19813.
- Valve cover plate with flow controls : N-45004.
- Inlet & exhaust isolator : N-45005. Inlet isolator : N-45006. Exhaust isolator : N-45007

Options :

- BSPP threads. • High flow up to 0.3 C<sub>v</sub>, according to wattage and high flow mod.

**DIMENSIONS**

Dimensions shown are metric (mm)

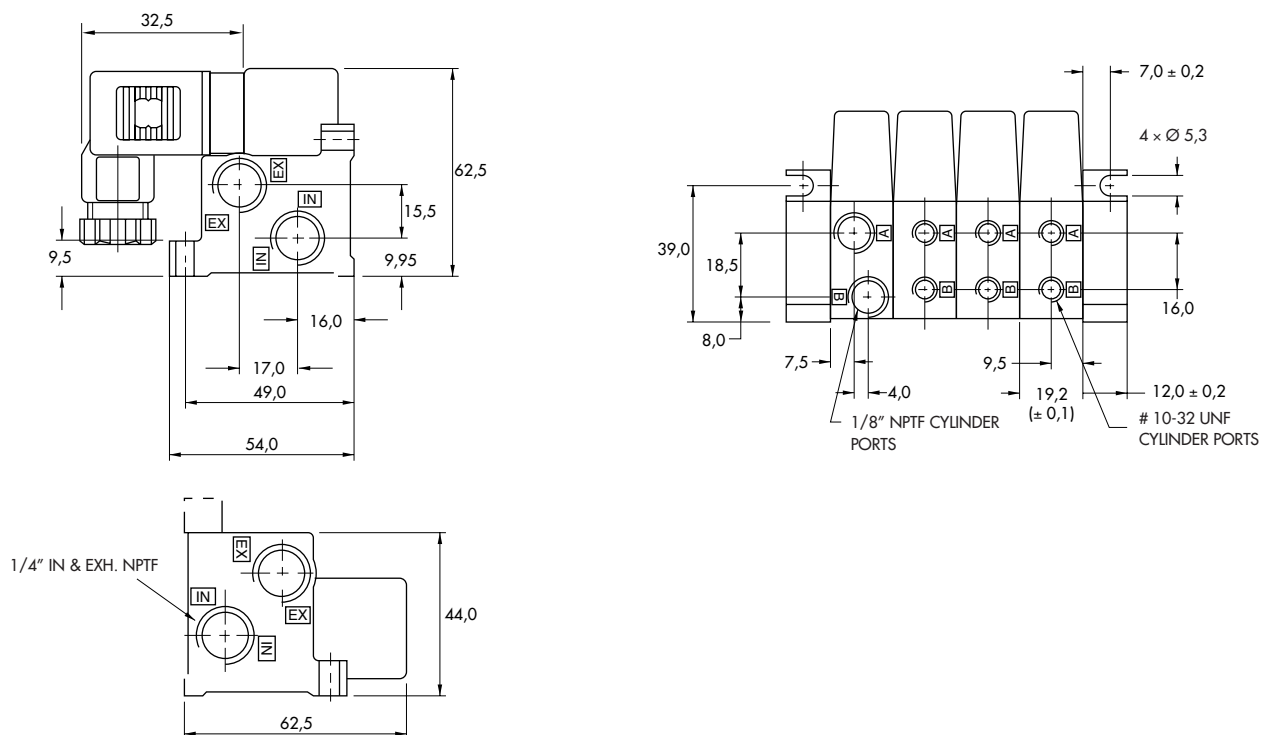





# Direct solenoid and solenoid pilot operated valves

Function	Port size	Flow (Max)	Manifold mounting	Series
4/2	# 10-32 - 1/8"	0.11 C <sub>v</sub>	sub-base non "plug-in"	

### OPERATIONAL BENEFITS

1. Balanced poppet, immune to variations of pressure.
2. Short stroke with high flow.
3. The patented solenoid develops high shifting forces.
4. Powerful return spring.
5. Manual operator standard on all valves.
6. Burn-out proof solenoid on AC service.

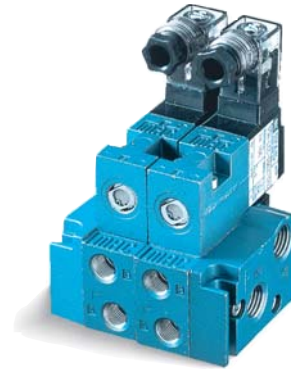

- 35
- 100
- 200
- 55
- 56
- 57
- 58
- 59

### HOW TO ORDER

Port size	Single operator	Double operator (Minimum DC wattage 5.4W)
<b>Valve less base</b>	45A-L00-Dxxx-xxx	45A-N00-Dxxx-xxx
<b>1/8" NPTF base</b>	45A-LAC-Dxxx-xxx	45A-NAC-Dxxx-xxx
<b># 10-32 UNF base</b>	45A-LBC-Dxxx-xxx	45A-NBC-Dxxx-xxx

45

### WITH INTEGRATED FLOW CONTROLS

Port size	Single operator	Double operator (Minimum DC wattage 5.4W)
<b>Valve less base</b>	45A-L00-Dxxx-xxx	45A-N00-Dxxx-xxx
<b>1/8" NPTF base</b>	45A-LAD-Dxxx-xxx	45A-NAD-Dxxx-xxx
<b># 10-32 UNF base</b>	45A-LBD-Dxxx-xxx	45A-NBD-Dxxx-xxx

- 700
- 900
- 82

### SOLENOID OPERATOR >

D **XX X- X XX\***

XX	Voltage	X	Wire length	X	Manual operator	XX	Electrical connection
AA	120/60, 110/50	A	18" (Flying leads)	1	Non-locking	KA	Square connector
AB	240/60, 220/50	J	Connector	2	Locking	KD	Square connector with light
AC	24/60, 24/50					BA	Flying leads
FB	24 VDC (1.8 W)						
DA	24 VDC (5.4 W)						
DF	24 VDC (12.7 W)						

- 6300
- 6500
- 6600
- 1300

\* Other options available, see page 353.

End plate kit required (Port size 1/4" NPTF) : M-45008-01

- 800
- ISO 1
- ISO 2
- ISO 3
- MAC 125A
- MAC 250A
- MAC 500A

**TECHNICAL DATA**

<b>Fluid :</b>	Compressed air, vacuum, inert gases		
<b>Pressure range :</b>	Vacuum to 120 PSI		
<b>Lubrication :</b>	Not required, if used select a medium aniline point lubricant (between 180°F and 210°F)		
<b>Filtration :</b>	40 µ		
<b>Temperature range :</b>	0°F to 120°F (-18°C to 50°C)		
<b>Flow (at 6 bar, ΔP=1bar) :</b>	1.8 W : (0.09 C <sub>v</sub> ), 5.4 W : (0.11 C <sub>v</sub> )		
<b>Coil :</b>	General purpose class A, continuous duty, encapsulated		
<b>Voltage range :</b>	-15% to +10% of nominal voltage		
<b>Protection :</b>	Consult factory		
<b>Power :</b>	~ Inrush : 10.9 VA    Holding : 7.7 VA = 1.8 to 12.7 W		
<b>Response times :</b>	24 VDC (5.4 W)	Energize : 6 ms	De-energize : 2 ms
	120/60	Energize : 3-8 ms	De-energize : 2-7 ms

Spare parts :      • Solenoid operator (power ≥ 5.4 W) : DXXX-XXX, including mounting screws 35013.  
 • Seal (between solenoid and valve body) : 16402. • Seal between base and valve : 16453. • Seal between bases : 16455.  
 • Tie-rod (x2) : 19753. • Side cover plate with flow controls : N-45016.  
 • Inlet & exhaust isolator : N-45008. • Inlet isolator : N-45009. • Exhaust isolator : N-45010.

Options :            • BSPP threads. • High flow up to 0.18 C<sub>v</sub>, according to wattage and high flow Mod. • Bottom inlet : specify Mod. 0210.

**DIMENSIONS**

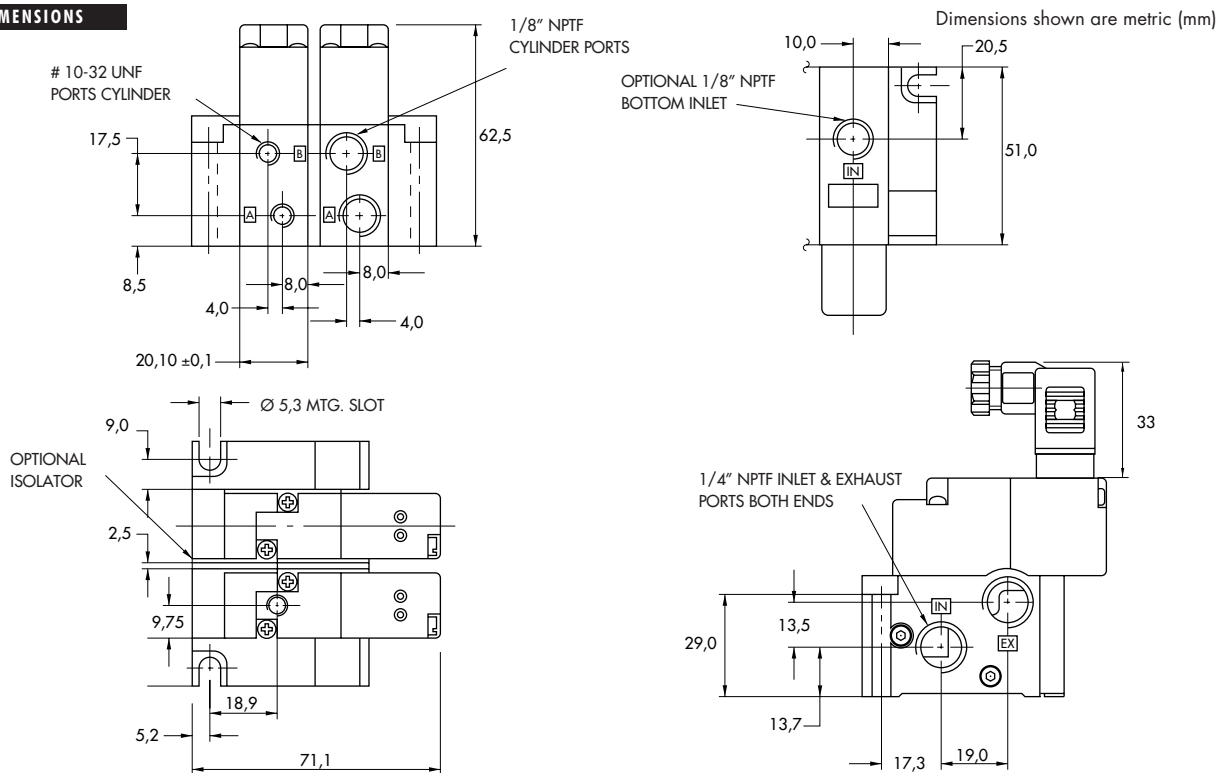



# Direct solenoid and solenoid pilot operated valves

Function	Port size	Flow (Max)	Manifold mounting	Series
4/2	# 10-32 - 1/8"	0.11 C <sub>v</sub>	sub-base with pressure regulators	

### OPERATIONAL BENEFITS

1. Balanced poppet, immune to variations of pressure.
2. Short stroke with high flow.
3. The patented solenoid develops high shifting forces.
4. Powerful return spring.
5. Manual operator standard on all valves.
6. Burn-out proof solenoid on AC service.



- 35
- 100
- 200
- 55
- 56
- 57
- 58
- 59

### HOW TO ORDER

Port size	Single operator	Double operator (Minimum DC wattage 5,4W)
<b>Valve less base</b>	45A-L00-Dxxx-xxx	45A-N00-Dxxx-xxx
<b>1/8" NPTF base</b>	45A-LAJ-Dxxx-xxx	45A-NAJ-Dxxx-xxx
<b># 10-32 UNF base</b>	45A-LBJ-Dxxx-xxx	45A-NBJ-Dxxx-xxx

45

### SOLENOID OPERATOR ▶

D **XX X- X XX\***

XX Voltage	X Wire length	X Manual operator	XX Electrical connection
AA 120/60, 110/50	A 18" (Flying leads)	1 Non-locking	KA Square connector
AB 240/60, 220/50	J Connector	2 Locking	KD Square connector with light
AC 24/60, 24/50			BA Flying leads
FB 24 VDC (1.8 W)			
DA 24 VDC (5.4 W)			
DF 24 VDC (12.7 W)			

- 700
- 900
- 82

\* Other options available, see page 353.

End plate kit required (Port size 1/4" NPTF) : M-45008-01.  
 Options (with gauge port) : Single operator : replace L by M.  
 Double operator : replace N by P.

### REGULATOR OPTIONS

45A-XXJ-D xxx-xxx ("J" is for Adj. knob)  
 — Replace with "E" for slotted stem  
 — Replace with "G" for locking slotted stem

- 6300
- 6500
- 6600
- 1300
- 800
- ISO 1
- ISO 2
- ISO 3
- MAC 125A
- MAC 250A
- MAC 500A

**TECHNICAL DATA**

<b>Fluid :</b>	Compressed air, vacuum, inert gases		
<b>Pressure range :</b>	Vacuum to 120 PSI		
<b>Lubrication :</b>	Not required, if used select a medium aniline point lubricant (between 180°F and 210°F)		
<b>Filtration :</b>	40 µ		
<b>Temperature range :</b>	0°F to 120°F (-18°C to 50°C)		
<b>Flow (at 6 bar, ΔP=1bar) :</b>	1.8 W : (0.09 C <sub>v</sub> ), 5.4 W : (0.11 C <sub>v</sub> )		
<b>Coil :</b>	General purpose class A, continuous duty, encapsulated		
<b>Voltage range :</b>	-15% to +10% of nominal voltage		
<b>Protection :</b>	Consult factory		
<b>Power :</b>	~ Inrush : 10.9 VA    Holding : 7.7 VA = 1.8 to 12.7 W		
<b>Response times :</b>	24 VDC (5.4 W)	Energize : 6 ms	De-energize : 2 ms
	120/60	Energize : 3-8 ms	De-energize : 2-7 ms

- Spare parts :
- Solenoid operator (power ≥ 5.4 W) : DXXX-XXX, including mounting screws 35013.
  - Seal (between solenoid and valve body) : 16402. • Seal between base and valve : 16453. • Seal between bases : 16455.
  - Tie-rod (x2) : 19753. • Pressure regulator : 45A-00R (Adj. Knob), 45A-00L (Slotted Stem), 45A-00M (Locking Slotted Stem).
  - Inlet & exhaust isolator : N-45008. • Inlet isolator : N-45009. • Exhaust isolator : N-45010.

- Options :
- BSPP threads. • High flow up to 0.18 C<sub>v</sub>, according to wattage and high flow mod. • Bottom inlet : specify Mod. 0210.

**DIMENSIONS**

Dimensions shown are metric (mm)

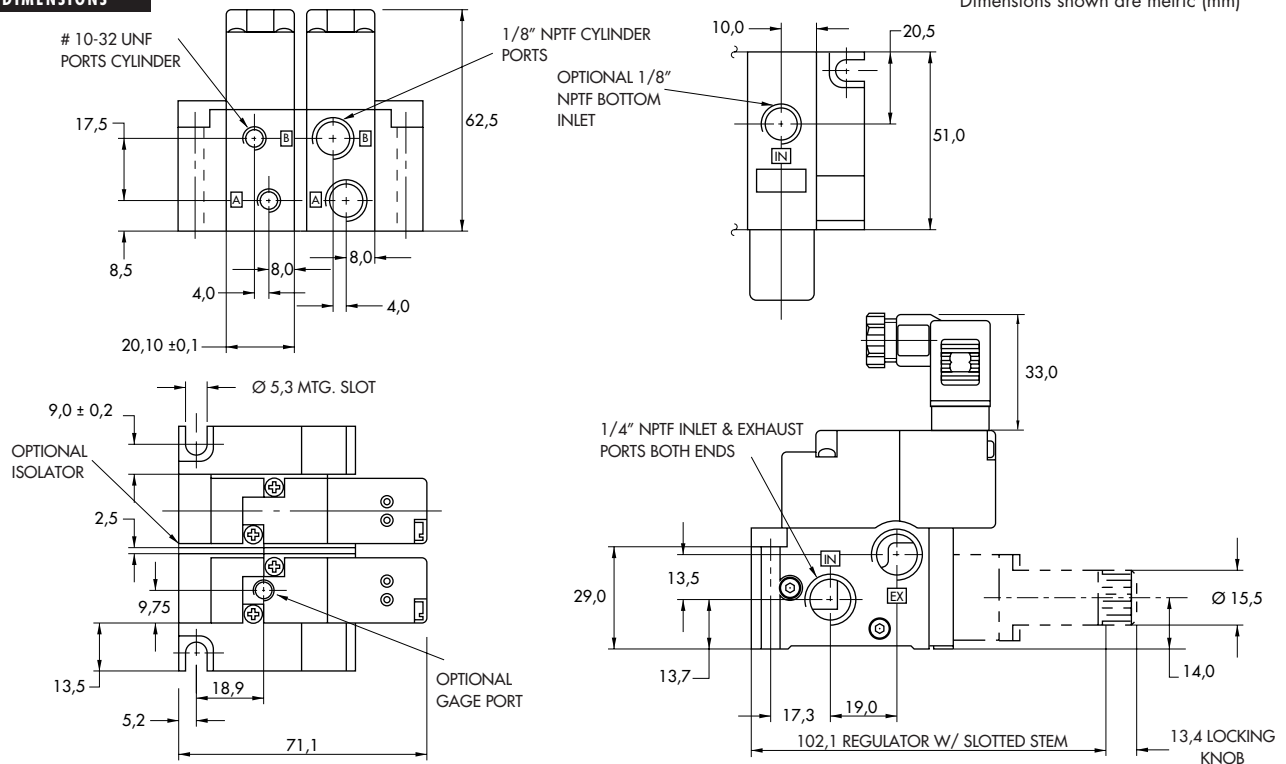

Function	Port size	Flow [Max]	Manifold mounting	Series
4/2	# 10-32 - 1/8"	0.11 C <sub>v</sub>	sub-base with pressure regulators and flow controls	

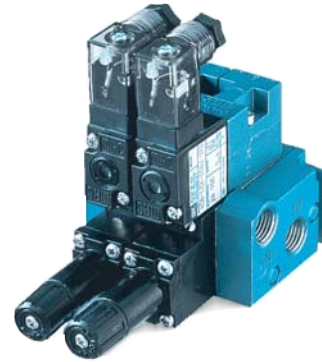

### OPERATIONAL BENEFITS

1. Balanced poppet, immune to variations of pressure.
2. Short stroke with high flow.
3. The patented solenoid develops high shifting forces.
4. Powerful return spring.
5. Manual operator standard on all valves.
6. Burn-out proof solenoid on AC service.

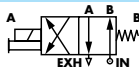

35  
100  
200  
55  
56  
57  
58  
59

### HOW TO ORDER

Port size	Single operator	Double operator (Minimum DC wattage 5,4W)
		
<b>Valve less base</b>	45A-L00-Dxxx-xxx	45A-N00-Dxxx-xxx
<b>1/8" NPTF base</b>	45A-LAK-Dxxx-xxx	45A-NAK-Dxxx-xxx
<b># 10-32 UNF base</b>	45A-LBK-Dxxx-xxx	45A-NBK-Dxxx-xxx

45

### SOLENOID OPERATOR ▶

D **XX X- X XX**\*

XX Voltage	X Wire length	X Manual operator	XX Electrical connection
AA 120/60, 110/50	A 18" (Flying leads)	1 Non-locking	KA Square connector
AB 240/60, 220/50	J Connector	2 Locking	KD Square connector with light
AC 24/60, 24/50			BA Flying leads
FB 24 VDC (1.8 W)			
DA 24 VDC (5.4 W)			
DF 24 VDC (12.7 W)			

700  
900  
82

\* Other options available, see page 353.

End plate kit required (Port size 1/4" NPTF) : M-45008-01.  
Options (with gauge port) : Single operator : replace L by M  
Double operator : replace N by P.

### REGULATOR AND F.C. OPTIONS

45A-XXK-D xxx-xxx ("K" option is for Adj. knob and F.C.)  
— Replace with "F" for slotted stem and F.C.  
— Replace with "H" for locking slotted stem and F.C.

6300  
6500  
6600  
1300  
800  
ISO 1  
ISO 2  
ISO 3  
MAC 125A  
MAC 250A  
MAC 500A

**TECHNICAL DATA**

<b>Fluid :</b>	Compressed air, vacuum, inert gases		
<b>Pressure range :</b>	Vacuum to 120 PSI		
<b>Lubrication :</b>	Not required, if used select a medium aniline point lubricant (between 180°F and 210°F)		
<b>Filtration :</b>	40 μ		
<b>Temperature range :</b>	0°F to 120°F (-18°C to 50°C)		
<b>Flow (at 6 bar, ΔP=1bar) :</b>	1.8 W : (0.09 C <sub>v</sub> ), 5.4 W : (0.11 C <sub>v</sub> )		
<b>Coil :</b>	General purpose class A, continuous duty, encapsulated		
<b>Voltage range :</b>	-15% to +10% of nominal voltage		
<b>Protection :</b>	Consult factory		
<b>Power :</b>	~ Inrush : 10.9 VA    Holding : 7.7 VA = 1.8 to 12.7 W		
<b>Response times :</b>	24 VDC (5.4 W)	Energize : 6 ms	De-energize : 2 ms
	120/60	Energize : 3-8 ms	De-energize : 2-7 ms

Spare parts :      • Solenoid operator (power ≥ 5.4 W) : DXXX-XXX, including mounting screws 35013.  
 • Seal (between solenoid and valve body) : 16402. • Seal between base and valve : 16453. • Seal between bases : 16455.  
 • Tie-rod (x2) : 19753. • Pressure regulator with flow controls : 45A-00N (Slotted Stem), 45A-00P (Locking Slotted Stem),  
 45A-00S(Adj. Knob). • Inlet & exhaust isolator : N-45008. • Inlet isolator : N-45009. • Exhaust isolator : N-45010.

Options :      • BSPP threads. • High flow up to 0.18 C<sub>v</sub>, according to wattage and high flow Mod. • Bottom inlet : specify Mod. 0210.

**DIMENSIONS**

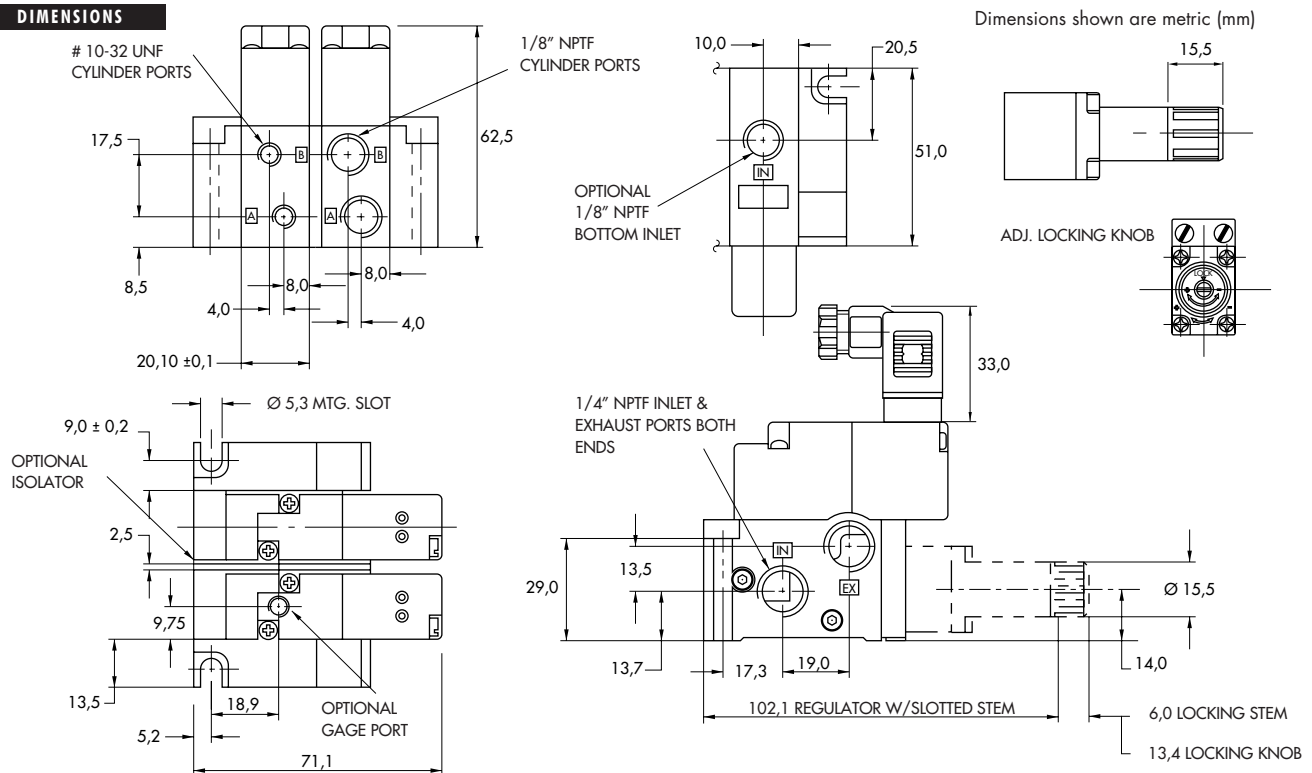

HOW TO ORDER

35A - **X X X** - (DXXX - XXX) - FM

BODY TYPE	PORT SIZE	SOLENOID OPTIONS	VALVE FUNCTION/MANIFOLD TYPE
<b>Inline</b> <b>A</b> Individual Inline <b>D</b> Indiv. Inline w/2 Manifold Mount Ports <b>Manifold</b> <b>E</b> Manifold Body (N.C. Only) <b>G</b> Manifold Body w/Gage Port (N.C. Only)	<b>O</b> Manifold Body Only <b>B</b> #10-32 UNF (Inline Only) <b>D</b> M5 (Inline Only)	<b>O</b> Manifold Body Only <b>B</b> 3 way N.C. Only (Inline)	Note : there is no manifold base for the 35 series. The manifold valve can only mount to a circuit bar, see note below

45A - **X X X** - (DXXX - XXX) - FM

BODY TYPE	PORT SIZE	SOLENOID OPTIONS	VALVE FUNCTION/MANIFOLD TYPE
<b>Inline</b> <b>A</b> 4 Port Body <b>B</b> 5 Port Body <b>D</b> 4 Port Body "O" Ring Mount -All Bottom Ports <b>E</b> 5 Port Body "O" Ring Mount -3 Bottom Ports Inlet and Cylinders <b>F</b> 4 Port Body "O" Ring Mount-Bottom Cylinder Ports Only <b>Base Mount</b> <b>O</b> For Base Only - No Valve <b>L</b> Base Mount Body <b>M</b> Base Mount Body with Gage Port	<b>O</b> Manifold Body Only <b>A</b> 1/8" NPT <b>B</b> #10-32 UNF <b>C</b> 1/8" BSPPL <b>D</b> M5 (Metric) <b>F</b> #10-32 UNF Bottom Ports <b>G</b> M5 Bottom Ports <b>H</b> "O" Ring Mount Ports <b>J</b> 1/8" NPT Bottom Ports <b>K</b> 1/8" BSPPL Bottom Ports	<b>Inline</b> <b>1</b> No Flow Controls <b>Bases - Regulators</b> <b>O</b> Valve Only - No Base <b>A</b> Individual Base <b>C</b> Manifold Base <b>E</b> Manifold w/Regulator w/Slotted Stem <b>G</b> Manifold w/Regulator w/Locking Slotted Stem <b>J</b> Manifold w/Regulator w/Locking Knob	

MANIFOLD MOUNT ACCESSORIES

- M-45008-01** End Plate Kit
- 16455** Pressure Seal Between Manifold
- 19753** Tie Rod
- N-45008** Isolator Kit - Inlet and Exhaust
- N-45009** Isolator Kit - Inlet only
- N-45010** Isolator Kit - Exhaust only
- N-45015** End Cover Plate - Plain
- N-45016** End Cover Plate w/Flow Controls
- N-45017** Flow Control Needle Assembly

D - **X X X** - **X X X** - FM

VOLTAGE	LEAD LENGTH	MANUAL OPERATOR	ELECTRICAL CONNECTION
<b>FR</b> 12VDC (0.6 W) <b>FS</b> 24VDC (0.6 W)	<b>A</b> 18" Leads <b>B</b> 24" Leads <b>C</b> 36" Leads <b>D</b> 48" Leads <b>E</b> 72" Leads <b>J*</b> 6" Leads	<b>0</b> No operator <b>1</b> Non-locking Recessed <b>2</b> Locking Recessed <b>3</b> Non-locking Extended <b>4</b> Locking Extended	<b>BA</b> Grommet <b>CA</b> Conduit 1/2" NPS† <b>CM</b> Metal Conduit 1/2" NPS† <b>CN</b> Metal Conduit w/grd. 1/2" NPS† <b>External Plug-in</b> <b>FM</b> Plug-in (For ECD & ECE Bar) <b>JB</b> Rectangular Plug-in† <b>JM</b> Rectangular Male only† <b>KA</b> Mini Plug-in <b>KJ</b> Mini Plug-in Male only <b>TA</b> Dual Tabs (.110) Plain <b>TJ</b> Dual Tabs (.110) Plain

\*Use "J" for external plug-in connectors

NOTE : For valves mounted to a circuit bar reference MAC circuit bar Catalog for ordering info.  
 For the 35 series circuit bar, use MOD FM01 after circuit bar part number.

† Available on individual valves and circuit bars.



0 p t i o n s

---

**Codification table for voltages / Wire length / Manual operators / Electrical connections**

---

VALVE CODE >

**-DXX X - X XX**  
**1 2 3 4**

**OPTIONS AVAILABLE FOR**

- Solenoid valves 35, 45 and 82 Series

---



## 1. VOLTAGE

- D XX X - X XX	VOLTAGE
AA	120/60, 110/50
AB	240/60, 220/50
AC	24/60, 24/50
AD	24/60
AE	200/60
AF	240/50
AG	100/50, 100/60, 110/60
DA	24 VDC (5.4 W)
DB	12 VDC (5.4 W)
DC	12 VDC (7.5 W)
DD	24 VDC (7.3 W)
DE	12 VDC (12.7 W) - CLSFonly
DF	24 VDC (12.7 W) - CLSF only
DK	110 VDC (4.7 W)
DL	64 VDC (6 W)
DM	36 VDC (5.3 W)
DN	6 VDC (6 W)
DP	48 VDC (5.8 W)
DU	24 VDC (6 W)
EA	12 VDC (6 W)
FA	12 VDC (1.8 W)
FB	24 VDC (1.8 W)
FE	12 VDC (2.4 W)
FF	24 VDC (2.4 W)

## 2. WIRE LENGTH

- D XX X - X XX	WIRE LENGTH
A	18"
B	24"
C	36"
D	48"
E	72"
F	96"
J	For external plug-in connector ("J", "K" & "T" type electrical connection)
P	For plug-in valves (82 Series only)

**3. MANUAL OPERATOR**

<b>- D XX X - X XX</b>	<b>MANUAL OPERATOR</b>
<b>0</b>	No operator
<b>1</b>	Non-locking recessed
<b>2</b>	Locking recessed
<b>3</b>	Non-locking extended
<b>4</b>	Locking extended

**4. ELECTRICAL CONNECTION**

<b>- D XX X - X XX</b>	<b>ELECTRICAL CONNECTION</b>
<b>BA</b>	Flying leads
<b>BK</b>	BA with protection diode
<b>BL</b>	BA with protection varistor (M.O.V.)
<b>** CA</b>	1/2" NPS conduit
<b>** CM</b>	1/2" NPS metal conduit
<b>** CN</b>	1/2" NPS metal conduit w/ground
<b>** JB</b>	Rectangular connector
<b>** JD</b>	Rectangular connector with light
<b>** JM</b>	Rectangular connector, male only
<b>KA</b>	Square connector
<b>KB</b>	Square connector with protection diode
<b>KC</b>	Square connector with protection varistor (M.O.V.)
<b>KD</b>	Square connector with light
<b>KE</b>	Square connector with light and protection diode
<b>KF</b>	Square connector with light and protection varistor (M.O.V.)
<b>KG</b>	Square connector with LED light & diode
<b>KJ</b>	Square connector (male only)
<b>KK</b>	Square connector with protection diode (male only)
<b>KL</b>	Square connector with protection varistor (male only) (M.O.V.)
<b>TA</b>	Dual tabs
<b>TB</b>	TA with protection diode
<b>TD</b>	TA with light
<b>TE</b>	TA with light and protection diode
<b>TJ</b>	Dual tabs (male only)
<b>TK</b>	TJ with protection diode
<b>TM</b>	TJ with light
<b>TN</b>	TJ with light and protection diode
<b>DA*</b>	Plug-in connector
<b>DK*</b>	DA with protection diode
<b>DL*</b>	DA with protection varistor (M.O.V.)
<b>FM</b>	Plug-in
<b>FN</b>	Plug-in with diode
<b>FP</b>	Plug-in with M.O.V.

\* To be used with 82 Series only  
 \*\* Inline valves only for 35 & 45 series. No restrictions for 82 series.