

Individual mounting

Valve only -
 No base
 non "plug-in"
 Conform to
 ISO 15407/1

Series

Manifold mounting

Valve only -
 No base
 non "plug-in"
 Conform to
 ISO 15407/1

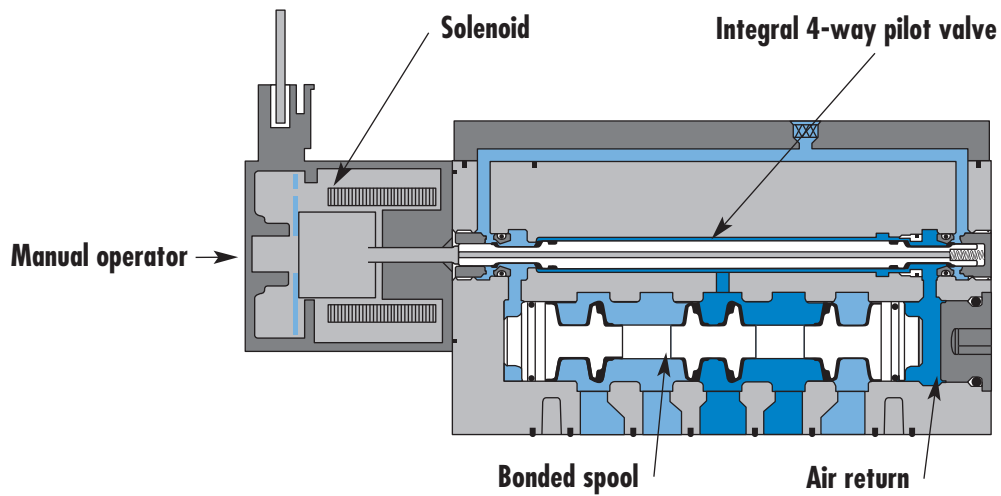

SERIES FEATURES

- High force MACSOLENOID®.
- Integral 4-way pilot design.
- 2-position, single or double operator.
- 3-position, double solenoid, open center, closed center and pressure center.
- Internal or external pilot.
- Single or dual pressure.

33
 34
 36
 32
 37
 38
 52
 67
 69
 44
 46
 42
 47
 48P
 48
 400
 92
 93

ISO 01
 ISO 02
 ISO 1
 ISO 2
 ISO 3

Function	Port size	Flow [Max]	Individual/Manifold mounting	Series
5/2, 5/3	1/4"	1.0 C_v	Valve only - No base non "plug-in" Conform to ISO 15407/1	

OPERATIONAL BENEFITS

1. Unique patented MACsolenoid® with oval shaped armature for fastest possible response times.
2. Balanced poppet 4-way pilot valve provides maximum shifting forces, precise repeatability and consistent operation.
3. MAC spool and bore combination wipes away contamination, eliminates sticking and allows for use on non-lube service.
4. Large spool area for maximum shifting forces even at minimum operating pressure.
5. Very high flow in a compact package. Pilot valve and main valve in the same body.
6. Internal or external pilot operation.
7. Air only return
8. Optional low wattage DC solenoid down to 1.0 Watt.



33
34
36
32
37
38
52
67
69
44

HOW TO ORDER

SINGLE PRESSURE MODELS

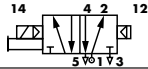
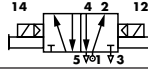
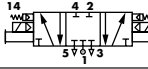
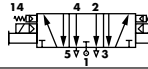
Pilot air	5/2 Single operator	5/2 Double operator	5/3 Closed center	5/3 Open center
Internal	 MV-A01A-AAMA-Jxxx-xxx	 MV-A01A-ABMA-Jxxx-xxx	 MV-A01A-AEMA-Jxxx-xxx	 MV-A01A-AFMA-Jxxx-xxx
External "12" end	MV-A01A-AAMD-Jxxx-xxx	MV-A01A-ABMD-Jxxx-xxx	MV-A01A-AEMD-Jxxx-xxx	MV-A01A-AFMD-Jxxx-xxx
External "14" end	MV-A01A-AAME-Jxxx-xxx	MV-A01A-ABME-Jxxx-xxx	MV-A01A-AEME-Jxxx-xxx	MV-A01A-AFME-Jxxx-xxx

46
42
47

DUAL PRESSURE MODELS

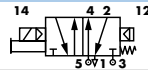
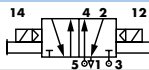
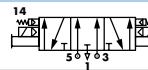
Pilot air	5/2 Single operator	5/2 Double operator	5/3 Pressure center
Internal from port #3	 MV-A01A-ACMB-Jxxx-xxx	 MV-A01A-ADMB-Jxxx-xxx	 MV-A01A-AHMB-Jxxx-xxx
Internal from port #5	MV-A01A-ACMC-Jxxx-xxx	MV-A01A-ADMC-Jxxx-xxx	MV-A01A-AHMC-Jxxx-xxx
External from "12" end	MV-A01A-ACMD-Jxxx-xxx	MV-A01A-ADMD-Jxxx-xxx	MV-A01A-AHMD-Jxxx-xxx
External from "14" end	MV-A01A-ACME-Jxxx-xxx	MV-A01A-ADME-Jxxx-xxx	MV-A01A-AHME-Jxxx-xxx

48P
48
400
92
93

SOLENOID OPERATOR >

J **xxx-xxx***

XX Voltage	X Lead wire length	X Manual operator	XX Electrical connection
DA 24 VDC (5.4W)	O No lead wire/ connector	1 Non-locking	BA Flying leads
DB 12 VDC (5.4W)	A 18"	2 Locking	JA Square connector
DC 24 VDC (2.4W)	B 24"		JC Square connector with light
DD 12 VDC (2.4W)	C 36"		JB Rectangular connector
DE 24 VDC (1.8W)			JD Rectangular connector with light
DU 24 VDC (1.0W)			KA Mini square connector
			KD Mini square connector with light

ISO 01
ISO 02
ISO 1
ISO 2
ISO 3

* Other options available, see page 317.

Note: - ISO series, valve and base are ordered separately, see page 227 for base codes.
- If sandwich regulator is required, valve must be ordered as external pilot. For internal pilot regulator use valve with external pilot 12 end, - for external pilot regulator, use valve with external pilot 12 or 14 end.

OPTIONS

Pilot exhaust: MV-A01A-XX X X-Jxxx-xxx

- M Pilot exhaust muffled
- P Pilot exhaust piped #10-32
- U Pilot exhaust out main exhaust

TECHNICAL DATA

Fluid :	Compressed air, vacuum, inert gases
Pressure range :	Internal Pilot - 2 pos.: 20 to 120 PSI - 3 pos.: 35 to 120 PSI External Pilot: Vacuum to 120 PSI
Pilot pressure :	2 pos.: 20 to 120 PSI - 3 pos.: 35 to 120 PSI
Lubrication :	Not required, if used select a medium aniline point lubricant (between 180°F and 210°F)
Filtration :	40 µ
Temperature range :	0°F to 120°F (-18°C to +50°C)
Flow :	2 pos.: Cv 1.0 – 3 pos.: Cv 0.8
Coil :	Class A wires continuous duty, #22 AWG x 18
Voltage range :	-15% to +10% of nominal voltage
Power :	1,0 to 5,4 W

- Options :
- Sandwich flow controls: FCA01A-AA (screwdriver slot adjustment).
 - Sandwich pressure regulator, see ,Regulators' section

DIMENSIONS

Individual base

Manifold base

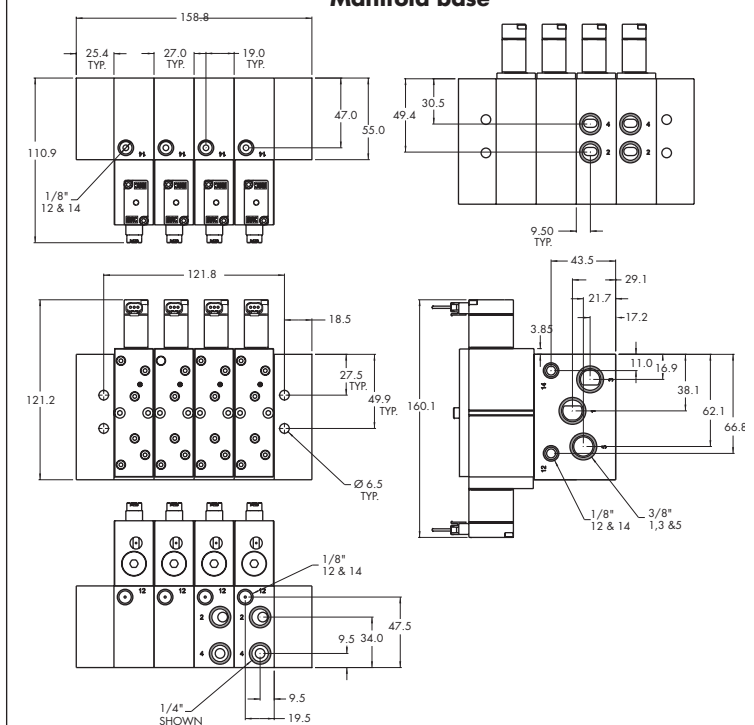

Non plug-in sandwich pressure regulator with manual adjust

OPERATIONAL BENEFITS

1. Easy mounting: saves on installation costs and space in comparison with inline regulators
2. Compact all-included units
3. Large orifice provides high flow
4. Various functions available
5. Simple, reliable and solid design



PR37A
PR42B
PR46A
PR47A
PR48B

PR92C

HOW TO ORDER

Pilot	Single pressure Regulator 12 end	Dual pressure Regulator 12 end with by-pass 14 end *	Dual pressure Regulator 14 end with by-pass 12 end *	Dual pressure Regulator both ends *
Internal	PRA01A-AAAA	PRA01A-ABAA	PRA01A-ADAA	PRA01A-AEAA
External	PRA01A-BAAA	PRA01A-BBAA	PRA01A-BDAA	PRA01A-BEAA

PR93A

Above models are for manual adjust with knob
 For other manual adjustments and pressure ranges, see Options.

Note: Add -9 after part number for regulator block assembled to valve.
 * To be used with dual pressure valves.

PRA01A
PRA02A

OPTIONS

Adjustments :

- PRA01A - **XXXX**
- A** Manual adjust with knob – Internal pilot
 - B** Manual adjust with knob – External pilot
 - G** Manual adjust with screwdriver slot – Internal pilot
 - H** Manual adjust with screwdriver slot – External pilot
 - K** Manual adjust with screwdriver slot with locknut– Internal pilot
 - L** Manual adjust with screwdriver slot with locknut – External pilot

PRA1A
PRP1A

PRA2D

Regulated Pressure range :

- PRA01A - **xxxx**
- A** 0 to 120 PSI
 - B** 0 to 80 PSI
 - C** 0 to 30 PSI
 - D** 0 to 120 PSI "14" end - 0 to 80 PSI "12" end
 - E** 0 to 120 PSI "12" end - 0 to 80 PSI "14" end
 - F** 0 to 120 PSI "14" end - 0 to 30 PSI "12" end
 - G** 0 to 120 PSI "12" end - 0 to 30 PSI "14" end
 - H** 0 to 80 PSI "14" end - 0 to 30 PSI "12" end
 - J** 0 to 80 PSI "12" end - 0 to 30 PSI "14" end

PRP2B

PRA3C

PRP3B

TECHNICAL DATA

Fluid :	Compressed air, inert gases
Pressure supply :	Higher than maximum regulated pressure (max. 8,5 bar)
Regulating range :	0 to 120 PSI
Lubrication :	Not required, if used select a medium aniline point lubricant (between 180°F and 210°F)
Filtration :	40 μ
Temperature range :	0°F to 120°F (-18°C to +50°C)

DIMENSIONS

Dimensions shown are metric (mm)

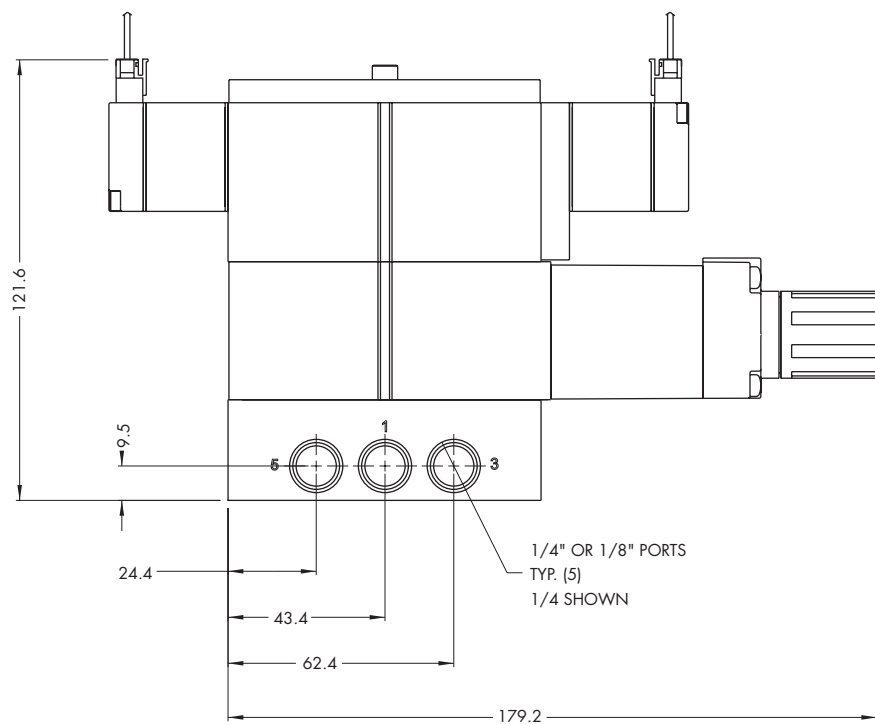



Non plug-in sandwich pressure regulator with air pilot adjust

OPERATIONAL BENEFITS

1. Easy mounting: saves on installation costs in comparison with inline regulators
2. Compact all-included units
3. Large orifice provides high flow
4. Various functions available
5. Simple, reliable and solid design

PR37A
PR42B
PR46A
PR47A
PR48B

PR92C

HOW TO ORDER

Pilot	Single pressure Regulator 12 end	Dual pressure Regulator 12 end with by-pass 14 end *	Dual pressure Regulator 14 end with by-pass 12 end *	Dual pressure Regulator both ends *
Internal	PRA01A-DAAA	PRA01A-DBAA	PRA01A-DDAA	PRA01A-DEAA
External	PRA01A-EAAA	PRA01A-EBAA	PRA01A-EDAA	PRA01A-EEAA

PR93A

Note : Only pressure range available for air adjust regulator is 0-120 PSI.
 * To be used with dual pressure valves.

PRA01A

PRA02A

PRA1A

PRP1A

PRA2D

PRP2B

PRA3C

PRP3B

TECHNICAL DATA

Fluid :	Compressed air, inert gases
Pressure range :	Higher than maximum regulated pressure
Regulating range :	0 to 120 PSI
Lubrication :	Not required, if used select a medium aniline point lubricant (between 180°F and 210°F)
Filtration :	40 μ
Temperature range :	0°F to 120°F (-18°C to +50°C)

DIMENSIONS

Dimensions shown are metric (mm)

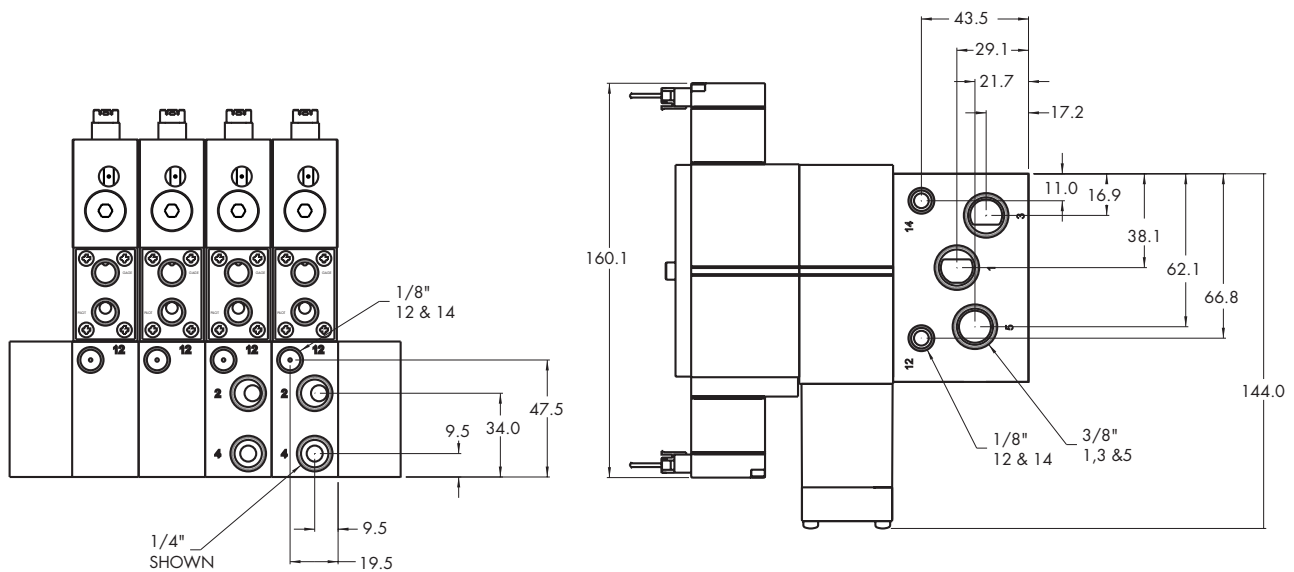

Non plug-in individual / manifold base



ISO 01

ISO 02

ISO 1

ISO 2

ISO 3

HOW TO ORDER

INDIVIDUAL BASE

Port size	Pilot air	Side ports	Bottom 2 & 4 ports With all side ports
1/4" NPTF	Internal	MB-A01A-121	MB-A01A-122

MANIFOLD BASE

Port size	Pilot air	Side ports	Bottom 2 & 4 ports With side 1, 3 & 5 ports
1/4" NPTF	Internal	MM-A01A-121	MM-A01A-122

Notes:

- For manifold bases external pilot is common
- A base is ordered as internal pilot and can be changed into external pilot by removing pipe plugs from the external pilot ports (individual base).
- Manifold base: same base for internal and external pilot, different end plate kits.

End plate kit: Internal pilot M-00017-01-01
External pilot M-00017-02-01

Inlet/exhaust isolator: 28413

DIMENSIONS

Dimensions shown are metric (mm)

Individual

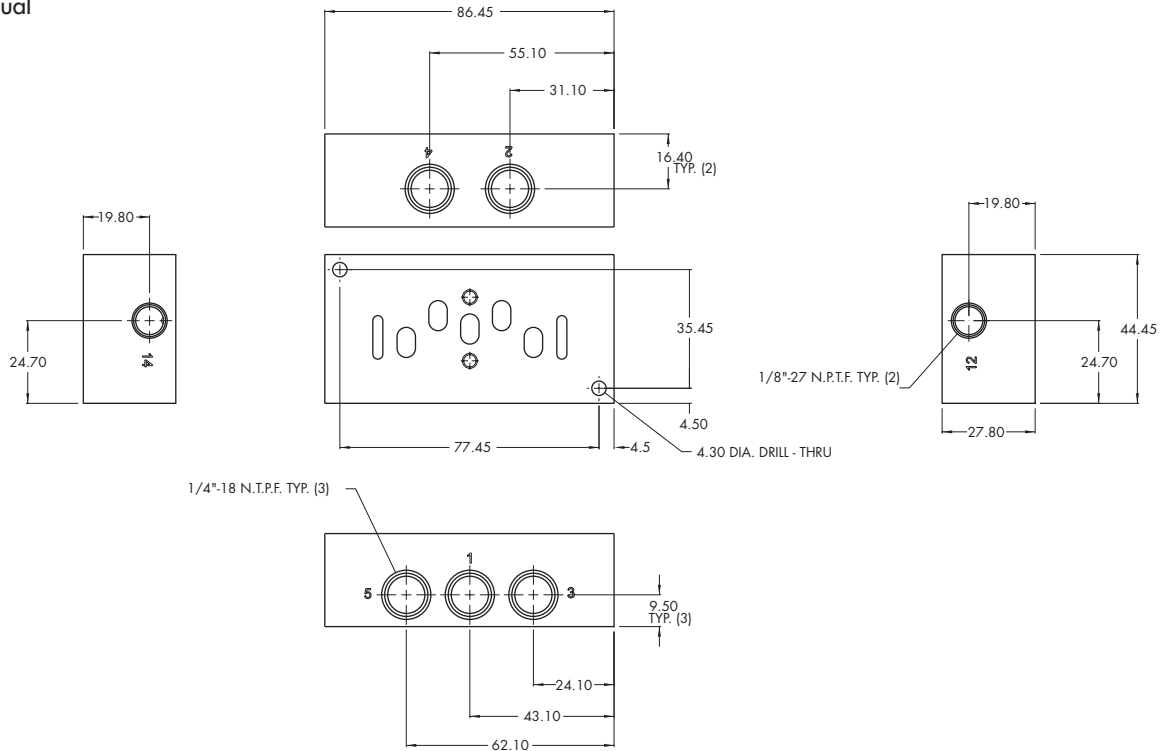

Manifold

LEFT SIDE

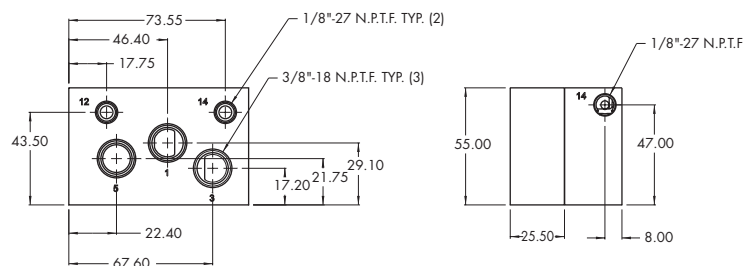

RIGHT SIDE

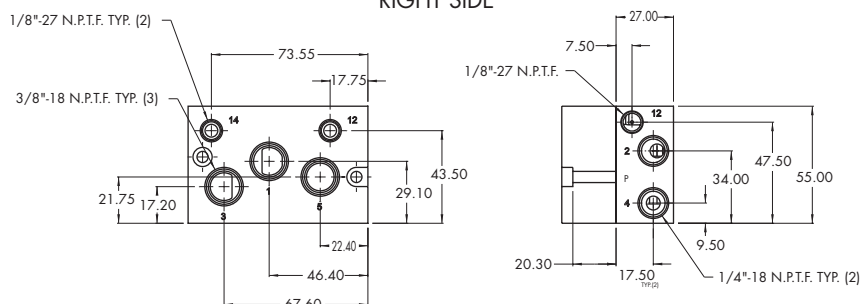

Codification table for voltages / Manual operators / Electrical connections

VALVE CODE > **J XX X-X XX**
1 2 3 4

OPTIONS AVAILABLE FOR

- Solenoid valves 36, 46, ISO 01 and ISO 02 Series

1. VOLTAGE

J-XX X-X XX	VOLTAGE
AA	120VAC (5.4W)
AC	24VAC (5.4W)
DE	24VDC (1.8W)
DF	12VDC (1.8W)
DJ	24VDC (1.3W)
DL	12VDC (1.3W)
DR	12VDC (1.0W)*
DU	24VDC (1.0W)*

* Not available on 36 series universal valve

2. WIRE LENGTH

J-XX X-X XX	WIRE LENGTH
A	18" coil leads
B	24" coil leads
C	36" coil leads
D	48" coil leads
E	72" coil leads
F	96" coil leads
P	Base plug-in
O	No leads (use with J, K & L type connectors)

3. MANUAL OPERATOR

J-XX X-X XX	MANUAL OPERATOR
0	No operator
1	Non-locking recessed
2	Locking recessed
3	Non-locking extended
4	Locking extended

4. ELECTRICAL CONNECTION

J-XX X-X XX	CONNECTORS FOR NON PLUG-IN VALVES ELECTRICAL CONNECTION
BA	Flying leads
GA	MAC JAC solenoid plug-in
GB	MAC JAC solenoid plug-in with diode
GC	MAC JAC solenoid plug-in with MOV
GD	MAC JAC solenoid plug-in with light
GE	MAC JAC solenoid plug-in with diode and light
GF	MAC JAC solenoid plug-in with MOV and light
GG	MAC JAC solenoid plug-in with rectifier
GH	MAC JAC solenoid plug-in with rectifier and light
GJ	MAC JAC solenoid plug-in – Male only
GK	MAC JAC solenoid plug-in with diode – Male only
GL	MAC JAC solenoid plug-in with MOV – Male only
GM	MAC JAC solenoid plug-in with light – Male only
GN	MAC JAC solenoid plug-in with diode and light – Male only
GP	MAC JAC solenoid plug-in with MOV and light – Male only
GR	MAC JAC solenoid plug-in with rectifier – Male only
GS	MAC JAC solenoid plug-in with rectifier and light – Male only
*JA	Square Connector
*JC	Square Connector with light
*JE	Square Connector with diode
*JF	Square Connector with MOV
*JG	Square Connector with diode/light
*JH	Square Connector with MOV/light
*JK	Square Connector with Rectifier

J-XX X-X XX

*JL	Square Connector with Rectifier with light
*JJ	Square Connector Male only (Plain)
*JB	Rectangular Connector
*JD	Rectangular Connector with light
*JN	Rectangular Connector with diode
*JP	Rectangular Connector with MOV
*JR	Rectangular Connector with diode/light
*JS	Rectangular Connector with MOV/light
*JT	Rectangular Connector with Rectifier
*JU	Rectangular Connector with Rectifier with light
*JM	Rectangular Connector Male only (Plain)

* Not available on manifold or stacking valves

**CONNECTORS FOR NON PLUG-IN VALVES
MINI SQUARE PLUG-IN CONNECTORS
9.4 MM SPACING BETWEEN PINS**

J-XX X-X XX	CONNECTORS FOR NON PLUG-IN VALVES MINI SQUARE PLUG-IN CONNECTORS 9.4 MM SPACING BETWEEN PINS
KA	Mini plug-in
KB	Mini plug-in with diode
KC	Mini plug-in with MOV
KD	Mini plug-in with light
KE	Mini plug-in with diode and light
KF	Mini plug-in with MOV and light
KG	Mini plug-in with rectifier
KH	Mini plug-in with rectifier and light
KJ	Mini plug-in – Male only
KK	Mini plug-in with diode - Male only
KL	Mini plug-in with MOV - Male only
KM	Mini plug-in with light - Male only
KN	Mini plug-in with diode and light – Male only
KP	Mini plug-in with MOV and light – Male only
KR	Mini plug-in with rectifier – Male only
KS	Mini plug-in with rectifier and light – Male only

**CONNECTORS FOR NON PLUG-IN VALVES
MINI SQUARE PLUG-IN CONNECTORS
8.0 MM SPACING BETWEEN PINS
ISO SPECIFICATION 15217**

J-XX X-X XX	CONNECTORS FOR NON PLUG-IN VALVES MINI SQUARE PLUG-IN CONNECTORS 8.0 MM SPACING BETWEEN PINS ISO SPECIFICATION 15217
LA	Mini plug-in
LB	Mini plug-in with diode
LC	Mini plug-in with MOV
LD	Mini plug-in with light
LE	Mini plug-in with diode and light
LF	Mini plug-in with MOV and light
LG	Mini plug-in with rectifier
LH	Mini plug-in with rectifier and light
LJ	Mini plug-in – Male only
LK	Mini plug-in with diode - Male only
LL	Mini plug-in with MOV - Male only
LM	Mini plug-in with light - Male only
LN	Mini plug-in with diode and light – Male only
LP	Mini plug-in with MOV and light – Male only
LR	Mini plug-in with rectifier – Male only
LS	Mini plug-in with rectifier and light – Male only

J-XX X-X XX	CONNECTORS FOR PLUG-IN VALVES
FA	Base plug-in
FB	Base plug-in with diode
FC	Base plug-in with MOV
FD	Base plug-in with light
FE	Base plug-in with diode and light
FF	Base plug-in with MOV and light
FG	Base plug-in with rectifier
FH	Base plug-in with rectifier and light

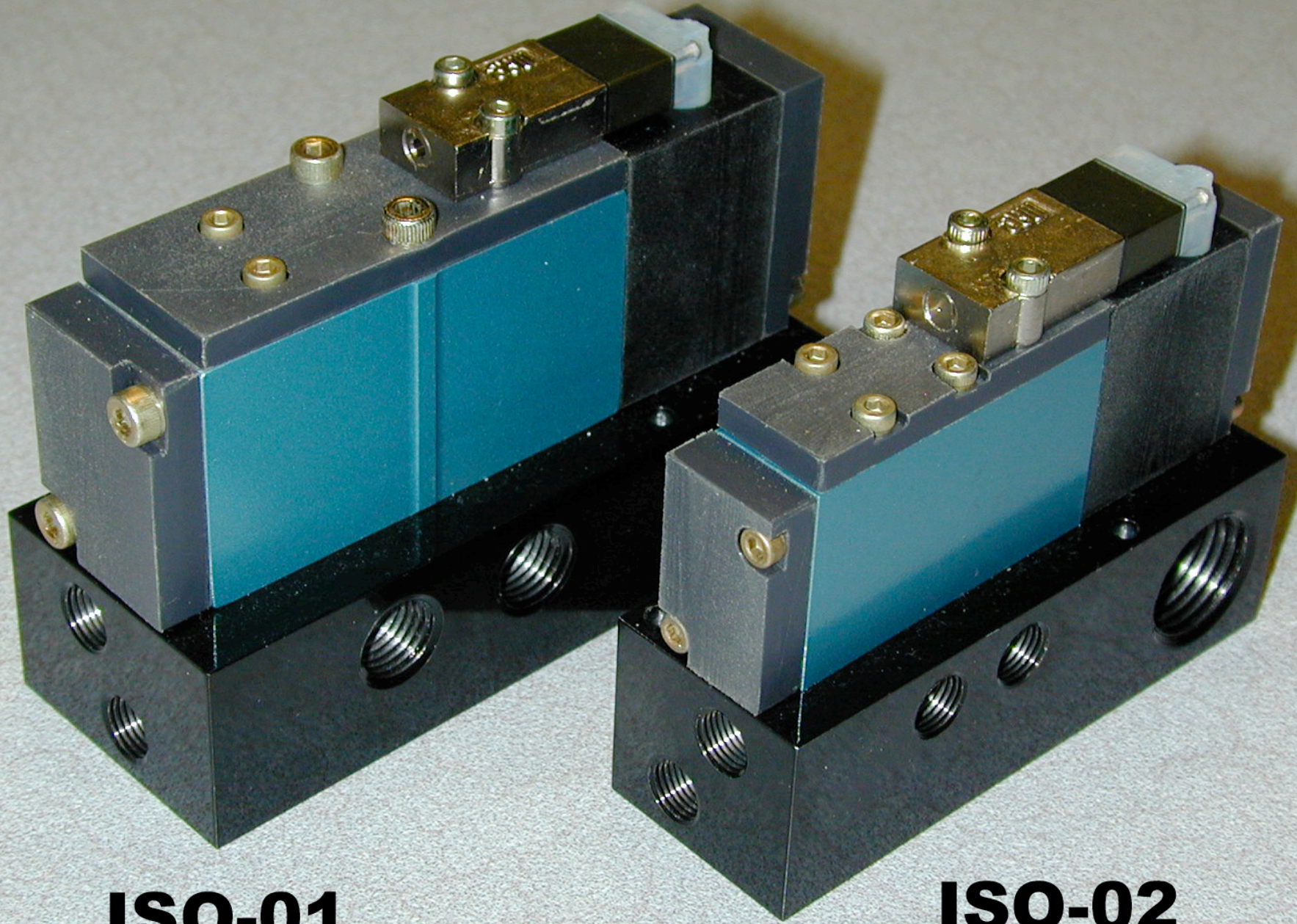

ISO-01

ISO-02

Specifications

ISO 01 and ISO 02 Series

Operating Data

- Fluids: Air or Inert Gas
- Lubrication: Not Required. But if used, a medium aniline range oil is recommended.
- Safe Operating Temperature Range: 0° to 120°F (-18° to 50°C)
- Pressure Range: Vacuum to 120 PSI (Ext. pilot supply provided for vacuum and low pressure)
 20 PSI minimum operating pressure on internal pilot. (2 position valves)
 35 PSI minimum operating pressure on internal pilot (3 position valves)
- Electrical: 24V, 120V: AC Voltage available by rectified DC supply.
 12V and 24V: DC Voltage (1.8 to 5.4 Watts)
- Above Coils: General Purpose Class A, Continuous duty.
- Coil Leads: #22 AWG x 18"

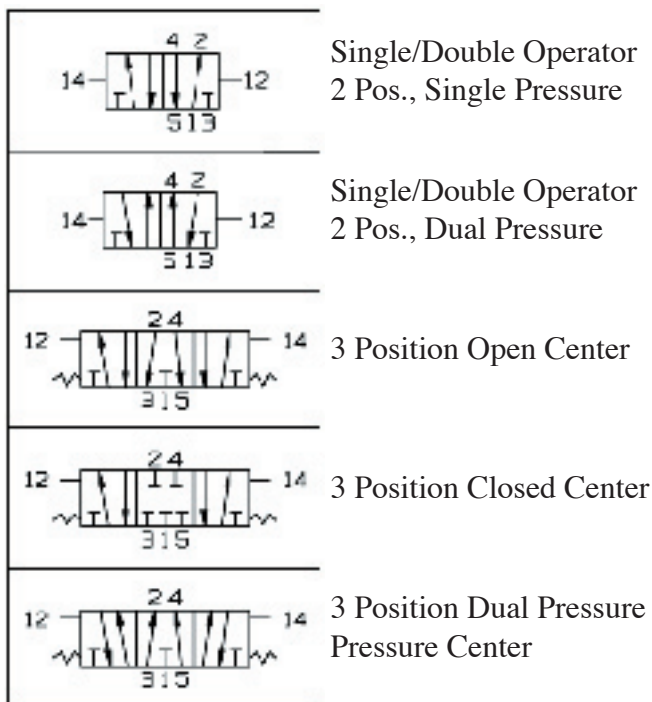

Pressure Range (PSI)

Description		Main Valve	Pilot
2 Position Single Sol.	Internal Pilot Models	20-120	N/A
2 Position Double Sol.		20-120	N/A
2 Position Single Sol.	External Pilot Models	VAC-120	20-120
2 Position Double Sol.		VAC-120	20-120
3 Position	Internal Pilot Models	35-120	N/A
3 Position	External Pilot Models	VAC-120	35-120

Flows (Cv)

ISO 01	ISO 02
2 Position : 1.0 Cv	2 Position : 0.51 Cv
3 Position : 0.8 Cv	3 Position : 0.35 Cv

Vacuum Applications

Use external pilot models only and connect the vacuum source to ports "3" and "5" and leave Port "1" open to atmosphere on single pressure models. On dual pressure models, reverse the single pressure piping.

Selector Applications (Without Regulators)

Connect the higher pressure to Port "1" and the lower pressure to either Port "3" or "5". If both pressures are below the minimum operating pressure, use an external pilot.

ISO #01 PLUG-IN (TOP VIEW)
CHART FOR LOCATION OF PASSAGE PLUGS
TO DETERMINE PILOT SUPPLY TO VALVE

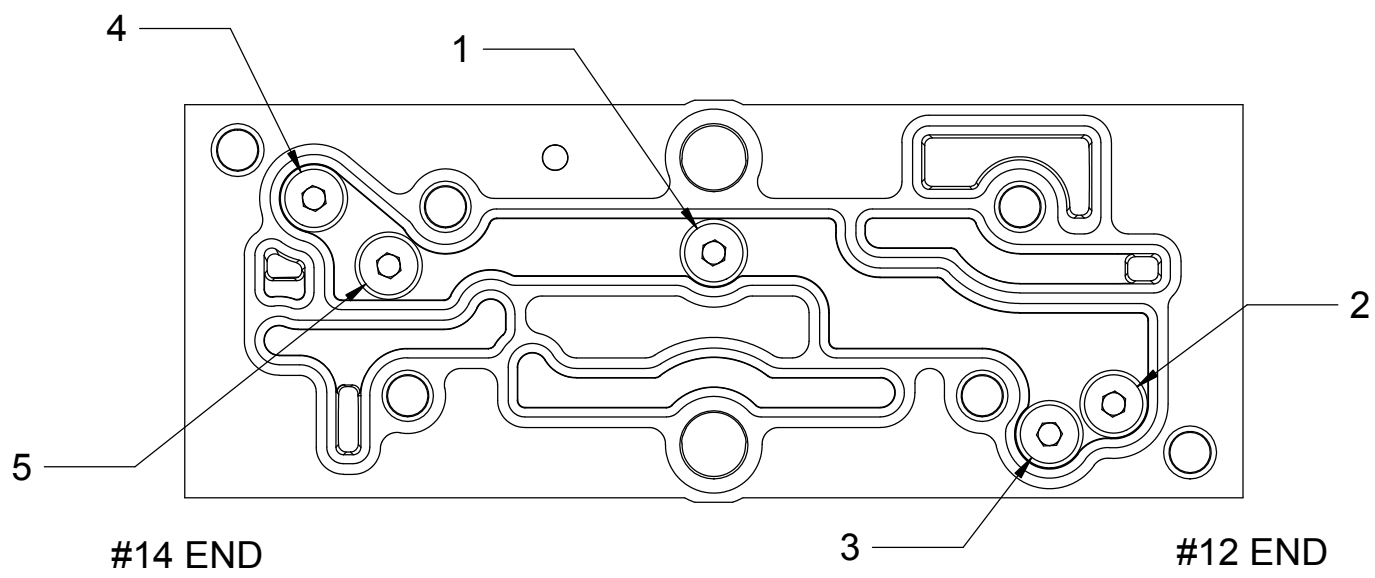

PILOT SUPPLY	PLUG LOCATION
SINGLE PRESSURE (INTERNAL)	2 , 3 , 4 , 5
SINGLE PRESSURE (EXTERNAL #12)	1 , 3 , 4 , 5
SINGLE PRESSURE (EXTERNAL #14)	1 , 2 , 3 , 5
DUAL PRESSURE(#3 PORT)	1 , 2 , 4 , 5
DUAL PRESSURE(#5 PORT)	1 , 2 , 3 , 4

ISO #02 PLUG-IN (TOP VIEW)
CHART FOR LOCATION OF PASSAGE PLUGS
TO DETERMINE PILOT SUPPLY TO VALVE

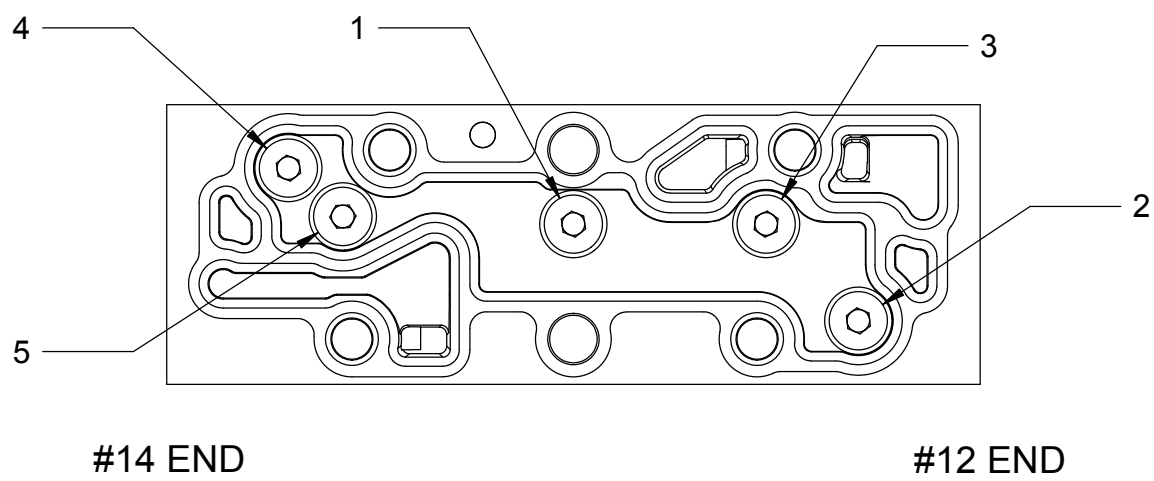

PILOT SUPPLY	PLUG LOCATION
SINGLE PRESSURE (INTERNAL)	2 , 3 , 4 , 5
SINGLE PRESSURE (EXTERNAL #12)	1 , 3 , 4 , 5
SINGLE PRESSURE (EXTERNAL #14)	1 , 2 , 3 , 5
DUAL PRESSURE(#3 PORT)	1 , 2 , 4 , 5
DUAL PRESSURE(#5 PORT)	1 , 2 , 3 , 4

How To Order ISO-01 Plug-in Valve

(ISO Standard 15407-2 Size 26)

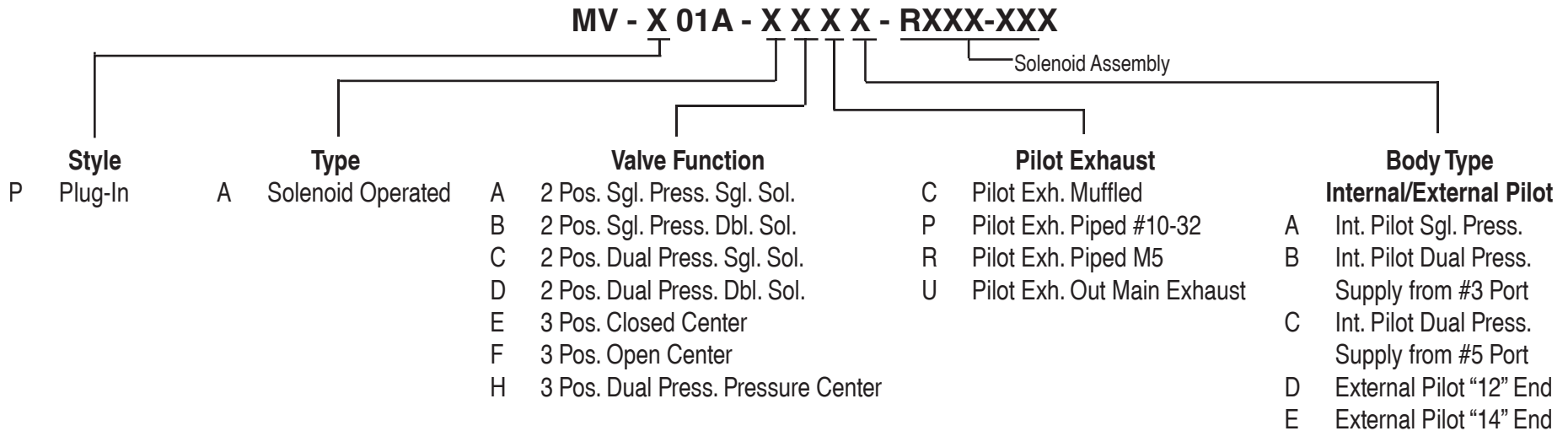

Note: If sandwich regulator is required valve must be ordered as external pilot. For internal pilot regulator use option "D". For external pilot regulator use option "D" or "E".

Note: External pilot regulator is only required when the primary pressure is below the minimum operating pressure of the valve.

How to Order

Solenoid Assembly (For ISO 01 and 02 Plug-In Valves)

R XX X - X XX

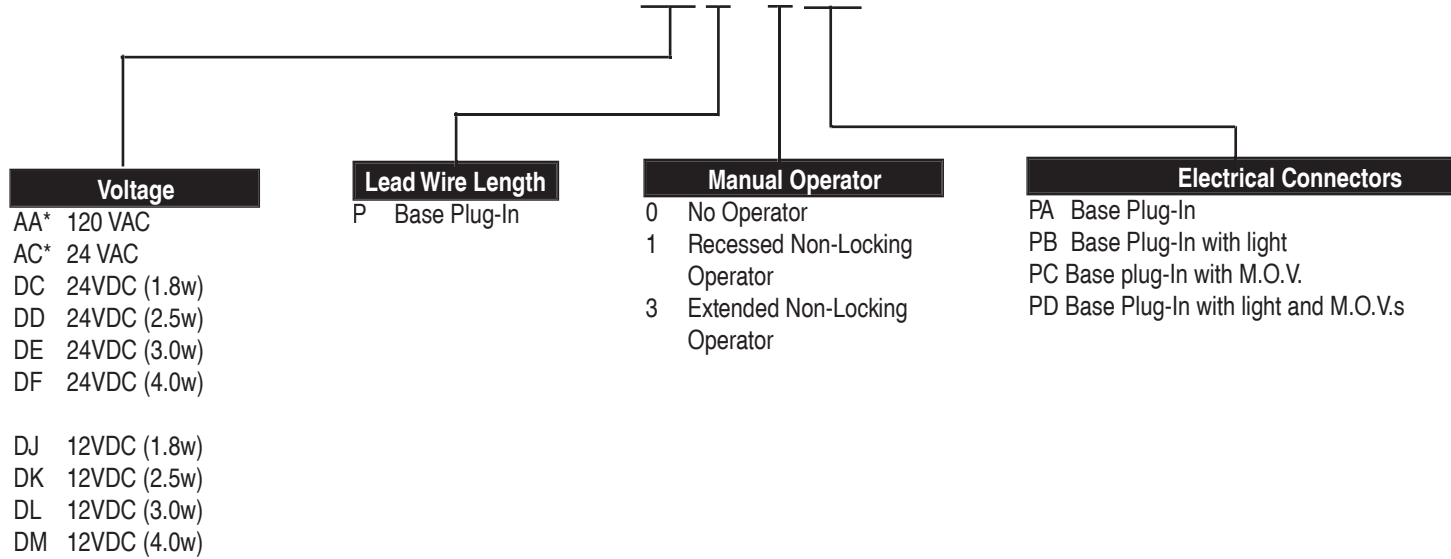

* Use either PA or PB Connector only

How To Order ISO-01 Plug-in Base/Manifold

(ISO Standard 15407-2 Size 26)

M X - P01 A - XX X (-9)

To Be Assembled To Valve

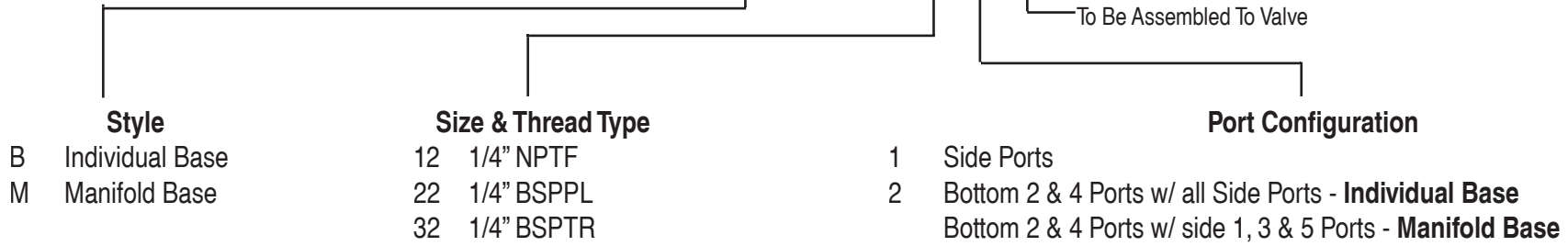

Note: For Manifold Bases External Pilot is Common

Parts

M-00020-01-01* Internal Pilot End Plate Kit
M-00020-02-01* External Pilot End Plate Kit

* Leave blank for NPTF threads, add "P" for BSPPL threads, add "T" for BSPTR threads.

How To Order ISO-01 Plug-in Regulator (ISO Standard 15407-2 Size 26)

PRP01A - X X X X - X

