

## I. Introducing : Proportional Pressure Controller

The MAC Proportional Pressure Controller, (PPC) is an innovative product which converts an electrical signal into a proportional pneumatic output. The PPC is unlike conventional I/P or V/P transducers. It offers much more in terms of performance, features, and reliability.

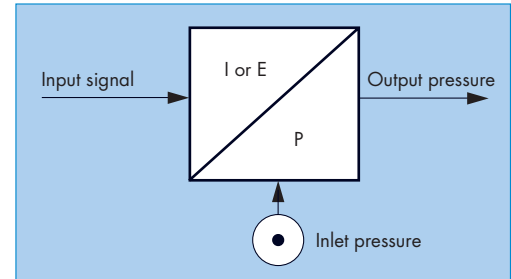

The key to the MAC PPCs are two MAC 34, 45, 400, 47, 92 or 93 Series valves that are used to control the output pressure. The valves are operated by the PPCs closed loop electronic control circuit. Feedback is obtained from one or two transducers. The balanced poppet, fast response, and high flow of these two MAC Valves provide outstanding performance characteristics for the PPC.

The PPC controls output pressure by constantly measuring its down stream pressure and comparing it to the command signal. If a higher pressure is commanded the PPC quickly responds by actuating the MAC fill valve, increasing the output pressure until it is equal to the pressure represented by the command signal. Conversely, if a lower pressure is required, the PPC will energize the MAC exhaust valve, decreasing output pressure until the correct pressure is achieved. All of this happens very quickly to smoothly maintain the correct pressure.

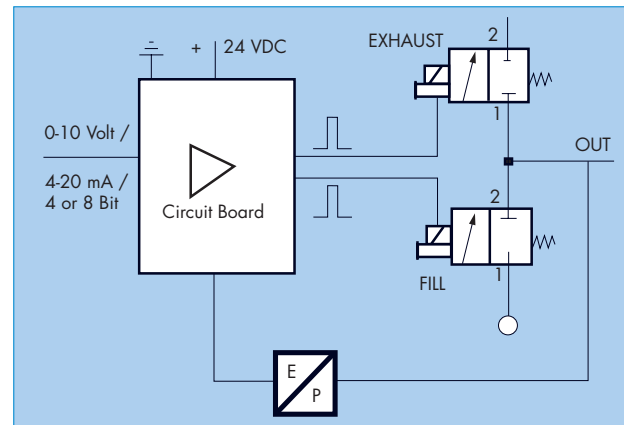

This approach to pressure control provides a small, light, and cost effective unit. Unlike voice coil units, the PPC is not affected by vibration or mounting position. Unlike large direct solenoid proportional units, the PPC is small and light, drawing little power, and producing little heat. Unlike units that utilize unbalanced air valves, the PPCs balanced valves provide high flow and extremely fast and repeatable response times as well as eliminating "undershoot" and "overshoot" problems normally associated with unbalanced valve designed units. Other proportional products often incorporate valves from third party manufacturers. All MAC PPCs utilize only fast shifting, repeatable, high flow, long life MAC Valves as fill and exhaust valves.

## II. Configuration

The PPC is available in many configurations.

The PPC5C can be ordered with a single or dual transducer, with an analog or digital command signal, for pressure or vacuum service. All other PPCs can be ordered with a single transducer with an analog command signal.

Single transducer PPCs can be configured with internal sensing (stand alone) or with external sensing (e.g. for Proportional Multi-Pressure Pak®).

Dual transducer PPCs are available for controlling other devices such as boosters.

PPCs with analog or digital command signal are chosen following the command device available for the application. Most PPC Series are available as covered or coverless devices. Coverless PPCs are intended for use in cabinets or areas protected from moisture while covered PPCs can be used in unprotected environments (Washdown).

MAC offers a multitude of special modifications designed to meet customers specific application requirements. Please contact your local MAC distributor for consultation if our standard product options do not fulfill your requirements.

### III. Specifications

#### LINEARITY

The linearity parameter shows the capability of the unit to follow the input signal according to an ideal straight line curve. MAC PPCs exhibit excellent linearity throughout the pressure range. The deviation is measured in  $\pm$  % of full scale.

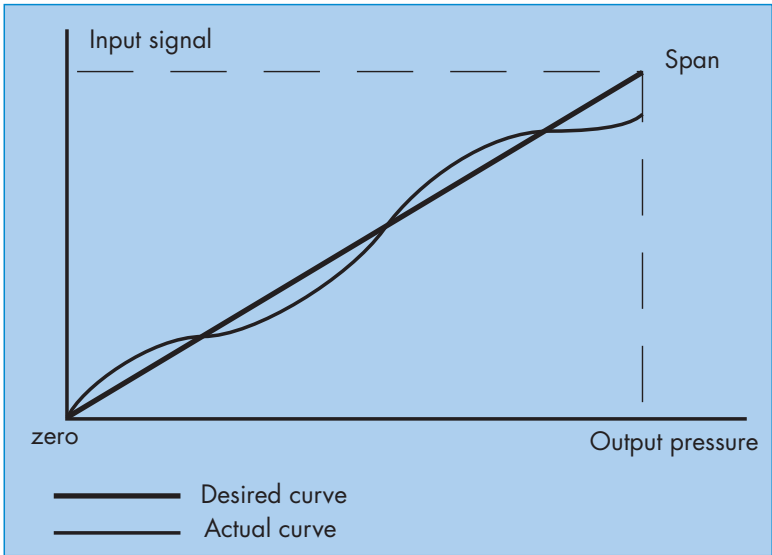

#### LIMITS OF ADJUSTMENT

For single transducer models, two parameters can be adjusted. Primarily these should be set by the factory but can be done in the field if absolutely necessary. The first parameter is the ZERO adjust, the second is the SPAN adjust. These parameters provide the possibility of customizing the PPC according to customers needs. However these adjustments are limited due to the tolerances of the transducers. If adjustments are necessary, please consult the factory or your local distributor

Note: Dual transducer models are not field adjustable.

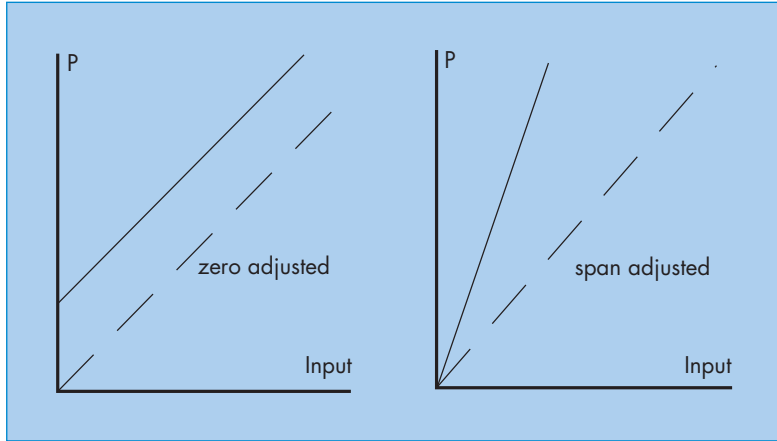

## HYSTERESIS

The hysteresis error, sometimes called “deadband”, is the amount of output pressure variance required to cause the PPC to react, making a correction to the output pressure. It is given in percent of full scale pressure, all MAC PPC products perform with minimal hysteresis.

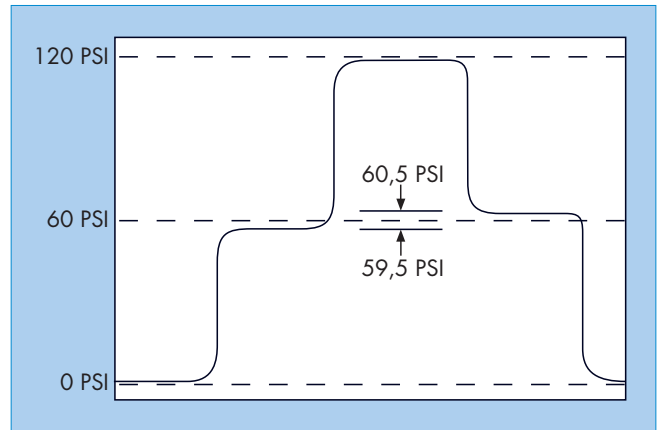

## ACCURACY

MAC Valves states accuracy of the MAC PPCs as overall accuracy. Accuracy is expressed in percent of full scale, which includes hysteresis and linearity. Some suppliers give separate parameters in order to give a better impression. In this case hysteresis and linearity are added. MAC PPCs are extremely accurate and maintain excellent control of output pressure well within our stated accuracy.

## OVERSHOOT – UNDERSHOOT

Two undesirable characteristics of other proportional control units available on the market are overshoot and undershoot.

Overshoot is a characteristic of the regulator to exceed the desired output pressure when the command signal is given. Undershoot is a characteristic of the regulator to fail to reach the desired output pressure.

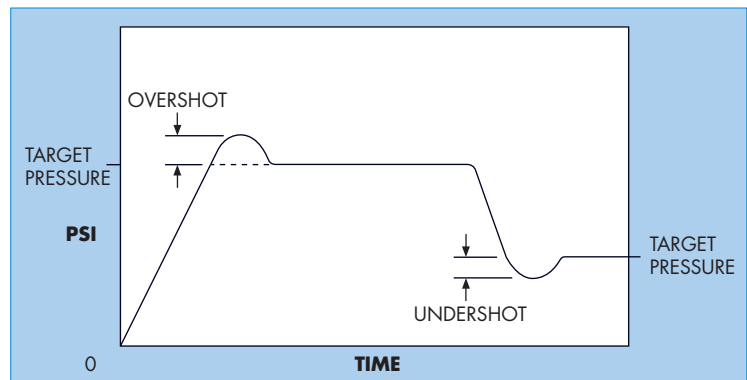

The PPC is based on a closed loop design which combined with MACs fast responding, very repeatable, high flow, balanced 2-way valves, optimizes response and accuracy, practically eliminating overshoot and undershoot.

## CLOSED END VOLUME

The closed end volume is the amount of volume needed to keep the PPC stable. If the closed volume to be filled is not appropriate for a particular PPC model (too small in comparison with the flow of air coming from the PPC), it will be very difficult to control the desired pressure inside this volume. So the PPC will be required to compensate for any small variation of pressure and the device will be unstable. This instability is sometimes referred to as “motorboating” or the continuous energizing and de-energizing of the fill and exhaust valves. Minimum volume requirements to prevent “motorboating” are listed for each PPC in this catalog for your reference.

## IV. Command Signal Options

The PPC can be controlled with either an analog command signal or a digital command signal.

### ANALOG COMMAND SIGNAL

The analog command signal can be either 0 – 10 VDC (voltage) or 4 – 20 mA (current).

Two wires are necessary to accept the command signal. The PPC measures the voltage differences between the two wires to determine the desired pressure output. Along with the command signals, a 24 VDC source must be available to operate the PPC. The return path for the 24VDC source and the return path for the command signal must not be isolated from each other. An example of how to wire the PPC with a differential command signal is shown below.

The major advantages of the command signal for the PPC are :

- Elimination of ground loop noise.
- Operation of multiple PPC's from a single power supply.
- Easy to connect to single-ended equipment.

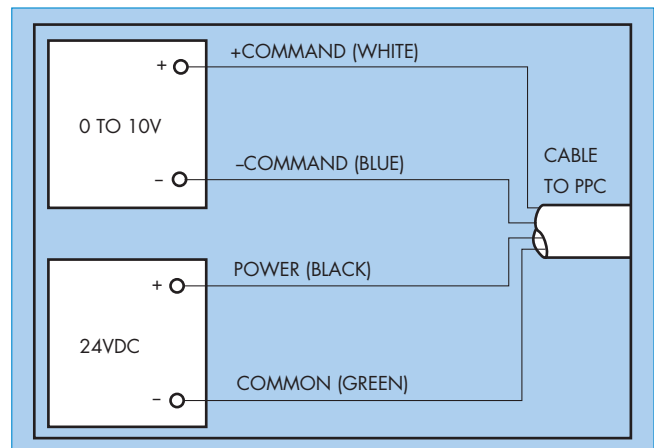

### DIGITAL COMMAND SIGNAL

The PPC, through the use of a converter board, accepts a digital command signal for 4-bit or 8-bit binary logic and converts this to an analog signal to produce a proportional pressure.

Using a 4-bit digital input, the maximum number of different pressures available at the output is 16. If an 8-bit digital input is specified, a much finer resolution (256 pressures at the output) can be obtained. For example, in a 100 PSI output system, using 4-bit logic, each bit is equal to 6.67 PSI. With an 8-bit digital, each bit is equal to .392 PSI

There are four different models available for the 4-bit and 8-bit digital PPC based on the type of input signal :

1. Positive Logic/Sourcing Input
3. Positive Logic/Sinking Input

2. Negative Logic/Sourcing Input
4. Negative Logic/Sinking Input

**Positive Logic** is defined as a minimum command level (all bits are logic low) controlling a minimum pressure output. For example, in a 4-bit system, a 0000 digital signal would correspond to zero psi and a 1111 digital signal would correspond to the maximum pressure.

**Negative Logic** is defined as a maximum command level (all bits are logic high) controlling a minimum pressure output. For example, in a 4-bit system, a 1111 digital signal would correspond to zero psi and a 0000 digital signal would correspond to the maximum pressure.

**Sinking Input** requires the digital voltage to be supplied by the controller connected to the input of the PPC. A command signal must be supplied by the external controller to the digital input connections. The PLC "drives" the PPC, by which a digital input (as opposed to analog) will control the output pressure.

**Sourcing Input** requires the PPC to produce the digital voltage. The controller connected to the input of the PPC is required to "pull the logic level down to zero" or to "maintain the logic level at one". "Zero" is considered that level of the signal which corresponds to the minimum value of the digital input supply (logic low). "One" is considered that level of the signal which corresponds to the maximum positive value of the digital input supply (logic high). In this case, the PPC "drives" the PLC. Again, a digital input will control the output pressure.

## V. Monitor Signal Options

The PPC is available with two optional monitor signals. The Analog Monitor Signal (AMS), and the Logic Monitor Signal (LMS). The PPC may be ordered with either one or both of these signals. Monitor Signals provide intelligent feedback to the controlling device.

### ANALOG MONITOR SIGNAL -AMS-

The Analog Monitor Signal is a 0 to 10 VDC feedback signal that provides a voltage proportional to the pressure output of the PPC or the output of the device it is controlling. In the case of MACs Proportional Multi-Pressure Pak®, the AMS signal provides a voltage output proportional to the output pressure of the PMPP.

The AMS may be used by the controlling device to verify that the correct pressure has been achieved. Also, the AMS may be connected to a voltage meter to display the pressure output. In some applications, the AMS is fed into the analog input of a controller to provide data for Statistical Process Control. In either case, a high impedance input is required for proper operation.

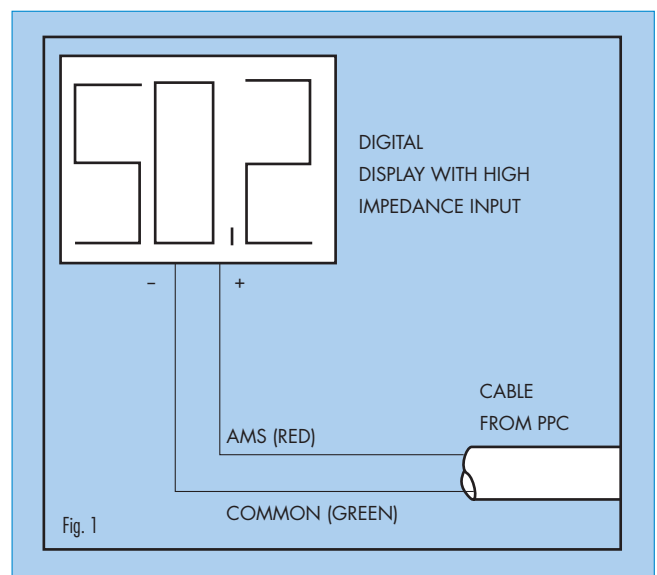

Figure 1, shows how to wire the AMS to a panel meter to display pressure output.

**LOGIC MONITOR SIGNAL -LMS-**

The Logic Monitor Signal provides digital feedback to confirm that the PPC has achieved the correct pressure. The LMS provides standard logic levels such as TTL (5V) or 24 VDC.

With the TTL option, when correct pressure is achieved, the LMS outputs a logic 1, (5 VDC). When the PPC is working, (Fill or Exhaust valve is in operation) the LMS outputs a logic 0, 0 VDC.

Figure 2 shows how to wire the LMS to a controller's TTL input.

The LMS provides a simple "go/no go" signal back to the controlling device. The LMS may also be used to turn on an L.E.D. for remote indication.

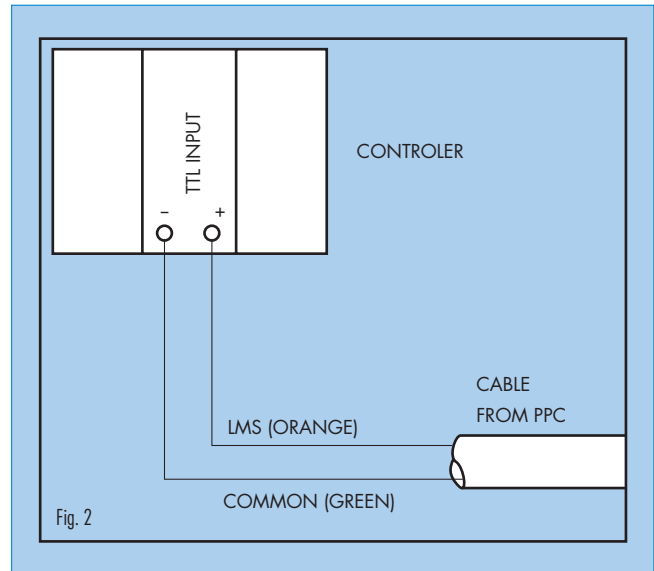

There also is a negative logic version (LMS) available. When the correct pressure is achieved, this option outputs a logic 0. When the PPC is working (fill or exhaust valve is in operation) the output is a logic 1. In either case, the LMS circuit is a sinking type of output. Thus, the PPC supplies the ground to the reading device.

**COVERLESS PPC WIRING PIN OUT**

**AMS - Analog Monitor Signal**

- 0-10 VDC feedback signal that provides a voltage proportional to the output pressure

**LMS 1 - Logic Monitor Signal**

- 5 VDC (TTL high), 24 VDC (high), 5 VDC (low), or 24 VDC (low) "go/no go" feedback signal (depending on requirements)

**LMS 2 - Logic Monitor Signal**

- 5VDC (TTL low), 24 VDC (high), or 24 VDC (low) "go/no go" feedback signal (depending on requirements)

**CV+ - Positive Command Signal**

- Positive lead for the 0 – 10 VDC or 4-20 MA command signal (depends on requirements)

**CV- - Negative Command Signal**

- Negative lead for the 0 – 10 VDC or 4-20 MA command signal (depends on requirements)

**COM - Main Power Common**

- Common lead for the 24 VDC power

**PWR - Main Power**

- Positive lead for the 24 VDC power

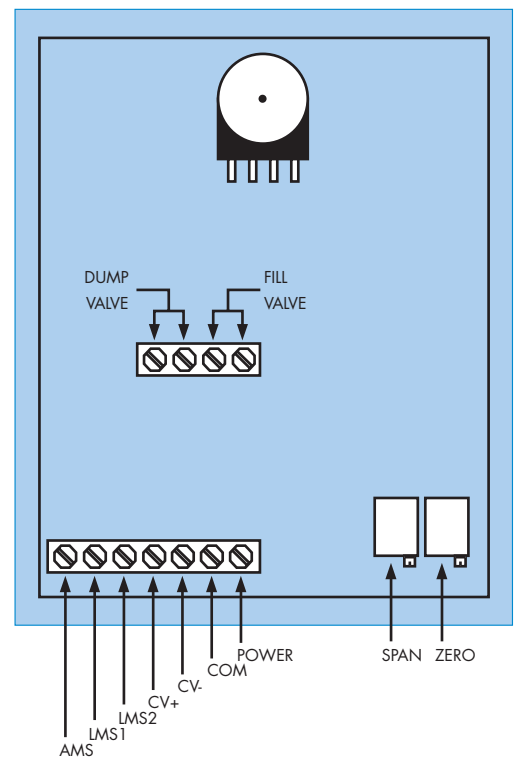

Port size

Flow [Max][Cv]

Individual mounting

1/8"

0.07 / 0.09

Covered Analog

## OPERATIONAL BENEFITS

1. Reliable operation, using two MAC 34 Series with balanced poppet.
2. Fast response.
3. Long life.
4. High flow.
5. Low power consumption.
6. Rugged enclosure.
7. Not affected by vibrations.
8. Accurate pressure control.
9. Can be stand alone or used in combination with our remote air sandwich regulators.
10. Analog command signal and output.



## HOW TO ORDER

BASIC MODEL

Revision

PPC5C XXX - XXXX - (XXX -XX -XX) See below

Type	Porting	Feedback options	Pressure range PSI/BAR	Pressure reference	Overall accuracy	Flow Cv/NI/min Fill Exh.
A Analog	SIDE PORTS A 1/8" NPTF B 1/8" BSPPL C 1/8" BSPTR BOTTOM PORTS D 1/8" NPTF E 1/8" BSPPL F 1/8" BSPTR G Bottom port O-ring Mount	A Single Xducer/ Int. Sense (Pressure) B Single Xducer/ Ext. Sense (Pressure) C Dual Xducer/ Int. Sense (Pressure)	A 100/6.7 B 60/4 C 30/2 D 15/1 E 50/3.3 F 80/5.3 G 2/0.13 H 20/1.3 J 75/5 K 117/7.8 L 4/0.26 M 150/10 N 10/0.66 P 90/6 V VACUUM	G Gage Pressure D Differential Pressure	A ± 1.5 % F.S. B ± 1.0 % F.S. C ± 0.5 % F.S. E ± 2.5 % F.S.	A 0.07/70 0.07/70 B 0.09/90 0.09/90 C 0.07/70 0.09/90

SIGNAL & CONNECTOR OPTIONS

XXX - XX - XX

Command signal	Analog monitor signal	Logic monitor signal (10mA, MAX)	Electrical connector	Cable length	Digital Display
B 0-10V C 4-20mA 3-Wire D 4-20mA 4-Wire	A None B 0-10V	A None B TTL (Low = Pressure Achieved) C TTL (High = Pressure Achieved) D 24V (Low = Pressure Achieved) E 24V (High = Pressure Achieved)	A 3 Pin Mini B 5 Pin Mini C 6 Pin Mini D 3 Pin Micro E 5 Pin Micro F 6 Pin Micro G 3 Wire Grommet H 4 Wire Grommet I 5 Wire Grommet J 6 Wire Grommet	O No Cable B 3 Ft/0.9m D 6 Ft/1.8m E 12 Ft/3.6m	Blank Not required DP Display PSI & com. signal DB Display Bar & com. signal

## IMPORTANT ! READ NOTES BEFORE ORDERING

- 1 For stand alone, choose Option "A".  
For PMPP, choose Option "B" and MOD 1164.  
For use with inline Boosters, choose Option "C".
  - 2 Feedback Option "C" not available with pressure ranges below 30 PSI. Maximum inlet pressure for Option "D" (15 PSI) is 30 PSI. Maximum inlet pressure for Options "G" (2 PSI) and "L" (4 PSI) is 15 PSI. Vacuum at inlet should not exceed 25" HG.
  - 3 Caution : Differential pressure must not exceed pressure range.
  - 4 For PMPPs, choose Option "A" or "E".  
For dual xducers, choose Option "B". Option "B" not available with single xducer.
  - 5 For PMPPs, choose Option "A".  
For any booster application, choose Option "A".  
For stand alone, "A" is standard; "B" is optional.
  - 6 For other options, consult the factory.
  - 7 See the list of standard electrical connectors before ordering.
  - 8 For Option "O" (no cable), choose electrical connector Options "A" through "F" only.
  - 9 This option is not available with feedback options "B" & "C", pressure range option "V" and pressure reference option "D".
- Note :** For PMPP ordering information, consult factory.  
For circuit bar® mounting of PPC5C, consult factory.

**GENERAL DATA**

<b>Ambient temperature :</b>	32°F to 120°F/0 to 50°C
<b>LED indicators :</b>	Red : power on - Green : pressure achieved
<b>Enclosure :</b>	Aluminium, sealed
<b>Vibration :</b>	Not affected
<b>Port size :</b>	G 1/8", 1/8" NPT - Option : bottom ports
<b>Connector :</b>	Micro or mini 3, 5 or 6 pin plug-in 3, 4, 5 or 6 wire grommet
<b>Mounting :</b>	Any plane
<b>Protection :</b>	IP 65

**ELECTRICAL DATA**

<b>Supply voltage :</b>	20.4 to 26.4 VDC
<b>Supply current :</b>	50 to 275mA (single transducer) 50 to 500mA (dual transducer)
<b>Command signal :</b>	0 to 10V or 4 to 20mA
<b>Command type :</b>	Single-ended or differential
<b>Input impedance :</b>	4.99 kΩ ± 1.0% (voltage) 316 Ω ± 0.1% (current)
<b>Analog Monitor Signal (AMS) :</b>	0 to 10 Volts
<b>Logic Monitor Signal (LMS) :</b>	TTL or 24V 10mA max. (sinking)
<b>EMI/RFI protection :</b>	Common mode and high frequency noise reduction for electrical inputs

**PNEUMATIC DATA**

<b>Inlet pressure* :</b>	160 PSI max (for 0-150 PSI output pres.) 10.7 BAR max (for 0-10 BAR output pres.) 120 PSI max (for 20-117 PSI output pres.) 8 BAR max (for 1.3-7.8 BAR output pres.)
<b>Inlet vacuum** :</b>	25" HG/635 mm HG
<b>Output vacuum :</b>	0 to 20" HG/0 to 508 mm HG
<b>Fluids :</b>	Compressed air or inert gases
<b>Lubrication :</b>	Not required. However, if used, a medium aniline point oil is recommended
<b>Output pressure :</b>	0 to 2, 4, 10, 15, 20, 30, 50, 60, 100, 117, 150 PSI (single transducer) 0 to 0.13, 0.26, 0.66, 1, 1.3, 2, 3.3, 4, 6.7, 7.8, 10 BAR (single transducer) 0 to 50, 60, 75, 80, 90, 100, 117, 150 PSI (dual transducer) 0 to 3.3, 4, 5, 5.3, 6, 6.7, 7.8, 10 BAR (dual transducer)
<b>Overall accuracy :</b>	± 1.5% full scale (single transducer standard) ± 1.0% full scale (dual transducer) ± 0.5% full scale (single transducer optional) ± 2.5% full scale (single transducer optional)
<b>Flow :</b>	Cv 0.07/70 NI/min (standard) - Cv 0.09/90 NI/min (High flow)
<b>Minimum closed end volume :</b>	1.0 cubic inch (Cv = 0.07) - 16 cm <sup>3</sup> (Flow = 70 NI/min)

\* 30 PSI maximum inlet for 15 PSI output pressure - 2 BAR maximum inlet for 1 BAR output pressure - 15 PSI maximum inlet for 2 PSI and 4 PSI output pressure - 1 BAR maximum inlet for 0.13 BAR output pressure  
\*\* Vacuum inlet should not exceed 25"/635 mm HG

**DIMENSIONS**

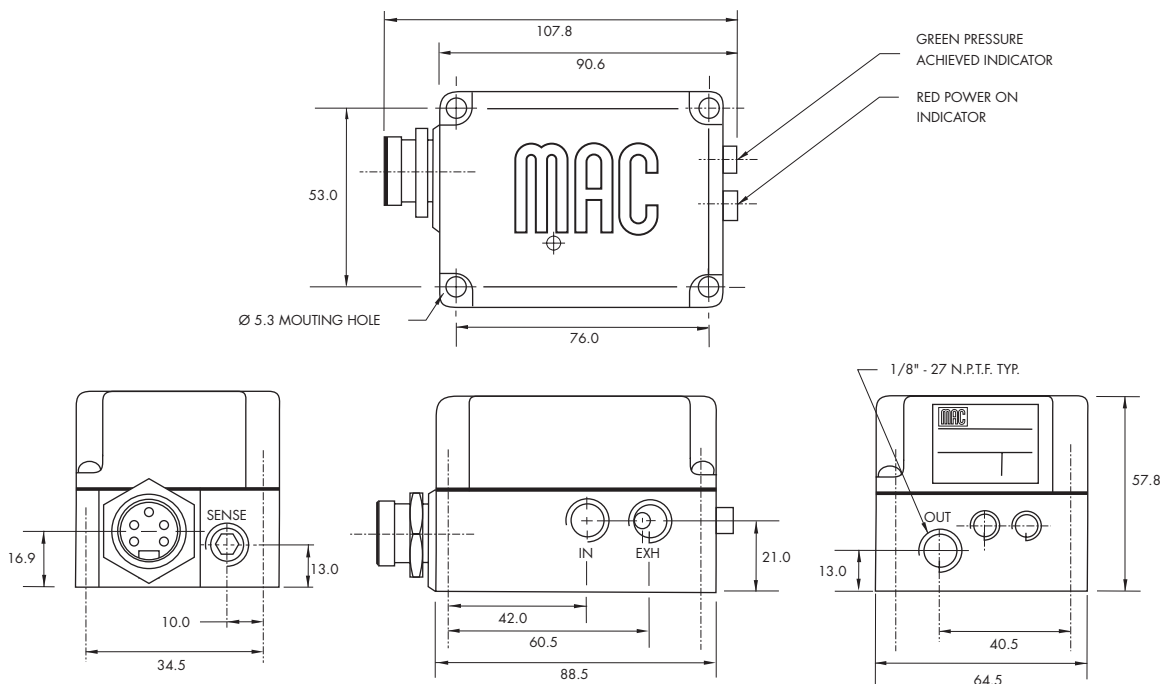



**OPTIONS**

LIST OF AVAILABLE SIGNAL & CONNECTOR OPTIONS

**PPC5C XXX - XXXX - (XXX - XX) - SIGNAL & CONNECTOR OPTIONS**

PART NO.	COMMAND SIGNAL	COMMAND TYPE	ANALOG MONITOR	LOGIC MONITOR	CONNECTOR DESCRIPTION
- CAA-AX	4-20mA	SINGLE	NONE	NONE	3-PIN
- CAA-DX	4-20mA	SINGLE	NONE	NONE	3-PIN MICRO
- CAA-GX	4-20mA	SINGLE	NONE	NONE	3-WIRE GROMMET
- BAA-HX	0-10V	DIFFERENTIAL	NONE	NONE	4-WIRE GROMMET
- DAA-HX	4-20mA	DIFFERENTIAL	NONE	NONE	4-WIRE GROMMET
- CBB-BX	4-20mA	SINGLE	0-10V	TTL	5-PIN
- CBD-BX	4-20mA	SINGLE	0-10V	24V	5-PIN
- BBA-BX	0-10V	DIFFERENTIAL	0-10V	NONE	5-PIN
- BAB-BX	0-10V	DIFFERENTIAL	NONE	TTL	5-PIN
- BAD-BX	0-10V	DIFFERENTIAL	NONE	24V	5-PIN
- DBA-BX	4-20mA	DIFFERENTIAL	0-10V	NONE	5-PIN
- DAB-BX	4-20mA	DIFFERENTIAL	NONE	TTL	5-PIN
- DAD-BX	4-20mA	DIFFERENTIAL	NONE	24V	5-PIN
- CBB-EX	4-20mA	SINGLE	0-10V	TTL	5-PIN MICRO
- CBD-EX	4-20mA	SINGLE	0-10V	24V	5-PIN MICRO
- BBA-EX	0-10V	DIFFERENTIAL	0-10V	NONE	5-PIN MICRO
- BAB-EX	0-10V	DIFFERENTIAL	NONE	TTL	5-PIN MICRO
- BAD-EX	0-10V	DIFFERENTIAL	NONE	24V	5-PIN MICRO
- DBA-EX	4-20mA	DIFFERENTIAL	0-10V	NONE	5-PIN MICRO
- DAB-EX	4-20mA	DIFFERENTIAL	NONE	TTL	5-PIN MICRO
- DAD-EX	4-20mA	DIFFERENTIAL	NONE	24V	5-PIN MICRO
- CBB-IX	4-20mA	SINGLE	0-10V	TTL	5-WIRE GROMMET
- CBD-IX	4-20mA	SINGLE	0-10V	24V	5-WIRE GROMMET
- BBA-IX	0-10V	DIFFERENTIAL	0-10V	NONE	5-WIRE GROMMET
- BAB-IX	0-10V	DIFFERENTIAL	NONE	TTL	5-WIRE GROMMET
- BAD-IX	0-10V	DIFFERENTIAL	NONE	24V	5-WIRE GROMMET
- DBA-IX	4-20mA	DIFFERENTIAL	0-10V	NONE	5-WIRE GROMMET
- DAB-IX	4-20mA	DIFFERENTIAL	NONE	TTL	5-WIRE GROMMET
- DAD-IX	4-20mA	DIFFERENTIAL	NONE	24V	5-WIRE GROMMET
- BBB-CX	0-10V	DIFFERENTIAL	0-10V	TTL	6-PIN
- BBD-CX	0-10V	DIFFERENTIAL	0-10V	24V	6-PIN
- DBB-CX	4-20mA	DIFFERENTIAL	0-10V	TTL	6-PIN
- DBD-CX	4-20mA	DIFFERENTIAL	0-10V	24V	6-PIN
- BBB-FX	0-10V	DIFFERENTIAL	0-10V	TTL	6-PIN MICRO
- BBD-FX	0-10V	DIFFERENTIAL	0-10V	24V	6-PIN MICRO
- DBB-FX	4-20mA	DIFFERENTIAL	0-10V	TTL	6-PIN MICRO
- DBD-FX	4-20mA	DIFFERENTIAL	0-10V	24V	6-PIN MICRO
- BBB-JX	0-10V	DIFFERENTIAL	0-10V	TTL	6-WIRE GROMMET
- BBD-JX	0-10V	DIFFERENTIAL	0-10V	24V	6-WIRE GROMMET
- DBB-JX	4-20mA	DIFFERENTIAL	0-10V	TTL	6-WIRE GROMMET
- DBDJX	4-20mA	DIFFERENTIAL	0-10V	24V	6-WIRE GROMMET

PPC5C

PPC34B

LCP35A

PPC45B

PPC47A

PPC400A









PPC92B

PPC93A

**OPTIONS**

STANDARD PLUG-IN - ELECTRICAL CONNECTIONS

PPC5C **XXX-XXXX-(XXX-XX)** - ELECTRICAL OPTIONS

	PART NO.	PIN	DESCRIPTION	MATING CORD
	- (CAA-AX)	3	1 COMMON 2 POWER +20.4 TO +26.4VDC 3 COMMAND	GREEN BLACK WHITE
	- (CAA-DX)	3 MICRO	1 COMMON 2 POWER +20.4 TO +26.4VDC 3 COMMAND	GREEN RED WITH BLACK TRACER RED WITH WHITE TRACER
	- (CBB-BX)	5 (SINGLE-ENDED)	1 + COMMAND 2 ANALOG MONITOR SIGNAL 3 COMMON 4 LOGIC MONITOR SIGNAL 5 POWER +20.4 TO +26.4VDC	WHITE RED GREEN ORANGE BLACK
	- (BBA-BX) - (BAB-BX) - (DBA-BX) - (DAB-BX)	5 (DIFFERENTIAL)	1 + COMMAND 2 - COMMAND 3 COMMON 4 LMS or AMS 5 POWER +20.4 TO +26.4VDC	WHITE RED GREEN ORANGE BLACK
	- (CBB-EX)	5 MICRO (SINGLE ENDED)	1 + COMMAND 2 ANALOG MONITOR 3 COMMON 4 LOGIC MONITOR SIGNAL 5 POWER +20.4 TO +26.4VDC	RED WITH WHITE TRACER RED GREEN RED WITH YELLOW TRACER RED WITH BLACK TRACER
	- (BBA-EX) - (BAB-EX) - (DBA-EX) - (DAB-EX)	5 MICRO (DIFFERENTIAL)	1 + COMMAND 2 - COMMAND 3 COMMON 4 LMS or AMS 5 POWER +20.4 TO +26.4VDC	RED WITH WHITE TRACER RED GREEN RED WITH YELLOW TRACER RED WITH BLACK TRACER
	- (BBB-CX) - (DBB-CX)	6	1 LOGIC MONITOR SIGNAL 2 - COMMAND 3 POWER +20.4 TO +26.4VDC 4 + COMMAND 5 ANALOG MONITOR SIGNAL 6 COMMON	ORANGE BLUE BLACK WHITE RED GREEN
	- (BBB-FX) - (DBB-FX)	6 MICRO	1 + COMMAND 2 ANALOG MONITOR SIGNAL 3 COMMON 4 LOGIC MONITOR SIGNAL 5 POWER +20.4 TO +26.4VDC 6 - COMMAND	RED WITH WHITE TRACER RED GREEN RED WITH YELLOW TRACER RED WITH BLACK TRACER RED WITH BLUE TRACER

STANDARD WIRE GROMMET - ELECTRICAL CONNECTIONS

PPC5C **XXX-XXXX-(XXX-XX)** - ELECTRICAL OPTIONS

PART NO.	WIRES	DESCRIPTION	WIRE COLOR
- (CAA-GX)	3	COMMON POWER +20.4 TO +26.4VDC COMMAND	GREEN RED WITH BLACK TRACER RED WITH WHITE TRACER
- (BAA-HX) - (DAA-HX)	4	COMMON POWER +20.4 TO +26.4VDC + COMMAND - COMMAND	GREEN RED WITH BLACK TRACER RED WITH WHITE TRACER RED WITH BLUE TRACER
- (CBB-IX)	5	COMMAND ANALOG MONITOR SIGNAL COMMON LOGIC MONITOR SIGNAL POWER +20.4 TO +26.4VDC	RED WITH WHITE TRACER RED GREEN RED WITH YELLOW TRACER RED WITH BLACK TRACER
- (BAB-IX) - (BBA-IX) - (DAB-IX) - (DBA-IX)	5	+ COMMAND - COMMAND COMMON LMS or AMS POWER +20.4 TO +26.4VDC	RED WITH WHITE TRACER RED GREEN RED WITH YELLOW TRACER RED WITH BLACK TRACER
- (BBB-JX) - (DBB-JX)	6	+ COMMAND ANALOG MONITOR SIGNAL COMMON LOGIC MONITOR SIGNAL POWER +20.4 TO +26.4VDC - COMMAND	RED WITH WHITE TRACER RED GREEN RED WITH YELLOW TRACER RED WITH BLACK TRACER RED WITH BLUE TRACER



# Proportional pressure controller

Port size	Flow [Max] [Cv/Nl/min]	Individual mounting	Series
1/8"	0.07/70 0.09/90	covered analog with remote transducer	

### OPERATIONAL BENEFITS

1. Reliable operation, using two MAC 34 Series with balanced poppet.
2. Fast response.
3. Long life.
4. High flow.
5. Low power consumption.
6. Rugged enclosure.
7. Not affected by vibrations.
8. Accuracy : ± 2.5 % full scale
9. Can be stand alone or used in combination with our remote air sandwich regulators.
10. Analog command signal and output.



PPC5C

PPC34B

LCP35A

PPC45B

PPC47A

PPC400A

PPC92B

PPC93A

### HOW TO ORDER

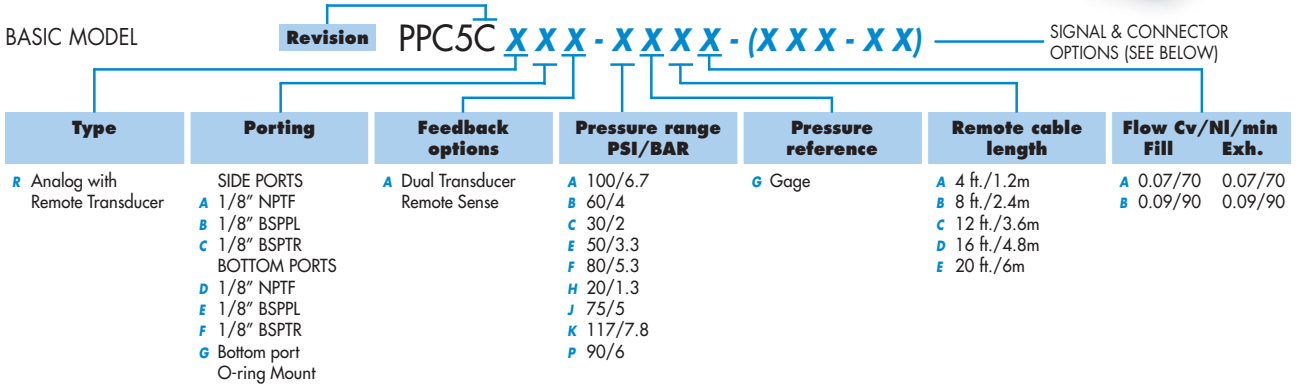

### SIGNAL & CONNECTOR OPTIONS

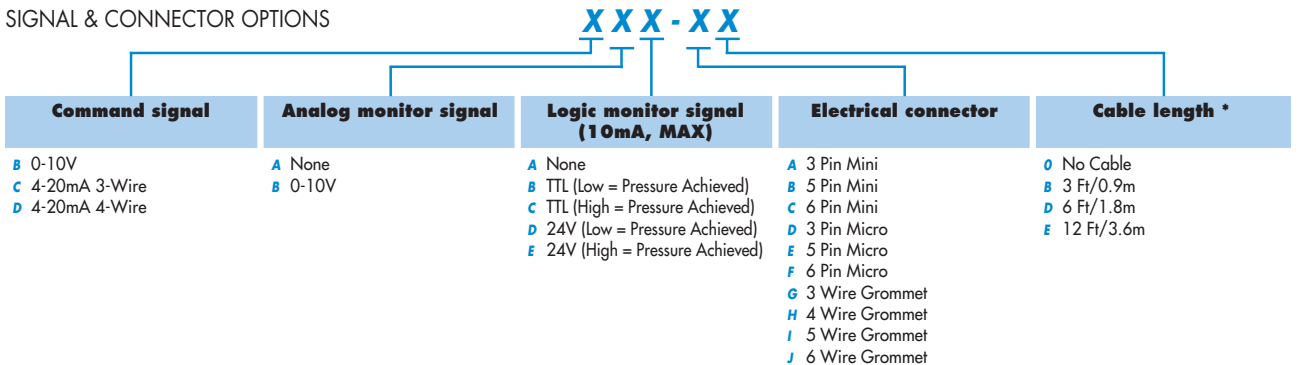

### NOTE :

\* For Option "O" (no cable), choose electrical connector Options "A" through "F" only.

EXAMPLE : PPC5C **RAA - AGAA - BBB - CB**

- Type:** Remote sense analog. Sealed aluminum hsg. with 1/8" NPT side ports
- Feedback:** Internal transducer sensing air pressure at the "out" port
- Pressure range:** 0 to 100 PSI output
- Pressure options:** Gage pressure with 4 ft. remote cable and Cv of 0.07
- Signal:** 0 to 10V differential command signal with analog and TTL Logic monitor signals
- Connector options:** 6 Pin Mini electrical connector for hook up and a 3 ft. cable

GENERAL DATA	
<b>Ambient temperature :</b>	PPC5C : 32 to 120°F/0 to 50°C Remote transducer : -40 to 185°F/-40 to 85°C
<b>LED indicators :</b>	Red : power on - Green : pressure achieved
<b>Enclosure :</b>	PPC5C : Aluminium, sealed Remote transducer : Aluminium, sealed
<b>Vibration :</b>	Not affected
<b>Port size :</b>	G 1/8", 1/8" NPT - Option : bottom ports
<b>Connector :</b>	Micro or mini 3, 5 or 6 pin plug-in 3, 4, 5 or 6 wire grommet
<b>Mounting :</b>	Any plane

ELECTRICAL DATA	
<b>Supply voltage :</b>	20.4 to 26.4 VDC
<b>Supply current :</b>	50 to 500mA
<b>Command signal :</b>	0 to 10V or 4 to 20mA
<b>Command type :</b>	Single-ended or differential
<b>Input impedance :</b>	4.99 kΩ ± 1.0% (voltage) 316 Ω ± 0.1% (current)
<b>Analog Monitor Signal (AMS) :</b>	0 to 10 Volts
<b>Logic Monitor Signal (LMS) :</b>	TTL or 24V 10mA max. (sinking)
<b>EMI/RFI protection :</b>	Common mode and high frequency noise reduction for electrical inputs

PNEUMATIC DATA	
<b>Inlet pressure* :</b>	120 PSI max (for 20-117 PSI output pres.) 8 BAR max (for 1.3-7.8 BAR output pres.)
<b>Fluids :</b>	Compressed air or inert gases
<b>Lubrication :</b>	Not required. However, if used, a medium aniline point oil is recommended
<b>Output pressure :</b>	0 to 20, 30, 50, 60, 75, 80, 90, 100, 117 PSI 0 to 1.3, 2, 3.3, 4, 5, 5.3, 6, 6.7, 7.8 BAR
<b>Overall accuracy :</b>	± 2.5% full scale
<b>Flow :</b>	Cv 0.07/70 NI/min (standard)
<b>Minimum closed end volume :</b>	50 cubic inch - 820 cm <sup>3</sup>

\* 20 PSI maximum inlet for 10 PSI output pressure - 1.3 BAR maximum inlet for 0.7 BAR output pressure

**DIMENSIONS**

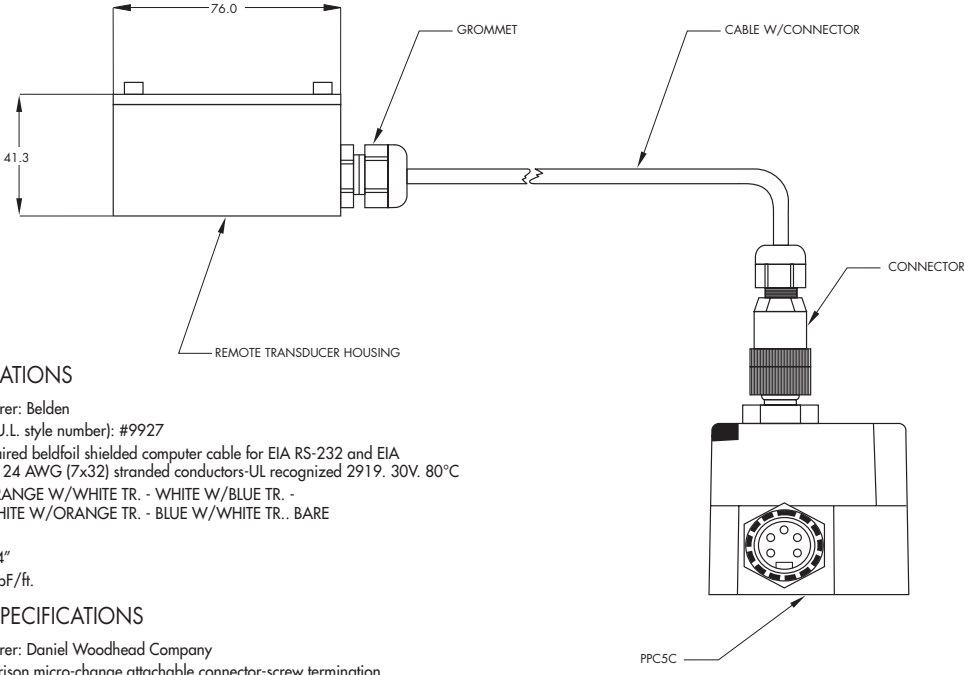

**CABLE SPECIFICATIONS**

- Approved manufacturer: Belden
- Cable type (trade & U.L. style number): #9927
- Cable description: paired beldfoil shielded computer cable for EIA RS-232 and EIA RS-422 applications. 24 AWG (7x32) stranded conductors-UL recognized 2919. 30V. 80°C
- Cable wire colors: ORANGE W/WHITE TR. - WHITE W/BLUE TR. - WHITE W/ORANGE TR. - BLUE W/WHITE TR.. BARE
- Number of pairs: 2
- Nominal O.D.: 0.244"
- Capacitance: 12.95 pF/ft.

**CONNECTOR SPECIFICATIONS**

- Approved manufacturer: Daniel Woodhead Company
- Connector: Brad Harrison micro-change attachable connector-screw termination
- Woodhead part number: 8A5000-31
- Contacts: Copper alloy, gold plated
- Voltage rating: 30VAC/35VDC
- Current rating: 4A

OPTIONS

LIST OF AVAILABLE SIGNAL & CONNECTOR OPTIONS

PPC5C **XXX-XXXX-(XXX-XX)** - SIGNAL & CONNECTOR OPTIONS

PART NO.	COMMAND SIGNAL	COMMAND TYPE	ANALOG MONITOR	LOGIC MONITOR	CONNECTOR DESCRIPTION
- CAA-AX	4-20mA	SINGLE	NONE	NONE	3-PIN
- CAA-DX	4-20mA	SINGLE	NONE	NONE	3-PIN MICRO
- CAA-GX	4-20mA	SINGLE	NONE	NONE	3-WIRE GROMMET
- BAA-HX	0-10V	DIFFERENTIAL	NONE	NONE	4-WIRE GROMMET
- DAA-HX	4-20mA	DIFFERENTIAL	NONE	NONE	4-WIRE GROMMET
- CBB-BX	4-20mA	SINGLE	0-10V	TTL	5-PIN
- CBD-BX	4-20mA	SINGLE	0-10V	24V	5-PIN
- BBA-BX	0-10V	DIFFERENTIAL	0-10V	NONE	5-PIN
- BAB-BX	0-10V	DIFFERENTIAL	NONE	TTL	5-PIN
- BAD-BX	0-10V	DIFFERENTIAL	NONE	24V	5-PIN
- DBA-BX	4-20mA	DIFFERENTIAL	0-10V	NONE	5-PIN
- DAB-BX	4-20mA	DIFFERENTIAL	NONE	TTL	5-PIN
- DAD-BX	4-20mA	DIFFERENTIAL	NONE	24V	5-PIN
- CBB-EX	4-20mA	SINGLE	0-10V	TTL	5-PIN MICRO
- CBD-EX	4-20mA	SINGLE	0-10V	24V	5-PIN MICRO
- BBA-EX	0-10V	DIFFERENTIAL	0-10V	NONE	5-PIN MICRO
- BAB-EX	0-10V	DIFFERENTIAL	NONE	TTL	5-PIN MICRO
- BAD-EX	0-10V	DIFFERENTIAL	NONE	24V	5-PIN MICRO
- DBA-EX	4-20mA	DIFFERENTIAL	0-10V	NONE	5-PIN MICRO
- DAB-EX	4-20mA	DIFFERENTIAL	NONE	TTL	5-PIN MICRO
- DAD-EX	4-20mA	DIFFERENTIAL	NONE	24V	5-PIN MICRO
- CBB-IX	4-20mA	SINGLE	0-10V	TTL	5-WIRE GROMMET
- CBD-IX	4-20mA	SINGLE	0-10V	24V	5-WIRE GROMMET
- BBA-IX	0-10V	DIFFERENTIAL	0-10V	NONE	5-WIRE GROMMET
- BAB-IX	0-10V	DIFFERENTIAL	NONE	TTL	5-WIRE GROMMET
- BAD-IX	0-10V	DIFFERENTIAL	NONE	24V	5-WIRE GROMMET
- DBA-IX	4-20mA	DIFFERENTIAL	0-10V	NONE	5-WIRE GROMMET
- DAB-IX	4-20mA	DIFFERENTIAL	NONE	TTL	5-WIRE GROMMET
- DAD-IX	4-20mA	DIFFERENTIAL	NONE	24V	5-WIRE GROMMET
- BBB-CX	0-10V	DIFFERENTIAL	0-10V	TTL	6-PIN
- BBD-CX	0-10V	DIFFERENTIAL	0-10V	24V	6-PIN
- DBB-CX	4-20mA	DIFFERENTIAL	0-10V	TTL	6-PIN
- DBD-CX	4-20mA	DIFFERENTIAL	0-10V	24V	6-PIN
- BBB-FX	0-10V	DIFFERENTIAL	0-10V	TTL	6-PIN MICRO
- BBD-FX	0-10V	DIFFERENTIAL	0-10V	24V	6-PIN MICRO
- DBB-FX	4-20mA	DIFFERENTIAL	0-10V	TTL	6-PIN MICRO
- DBD-FX	4-20mA	DIFFERENTIAL	0-10V	24V	6-PIN MICRO
- BBB-JX	0-10V	DIFFERENTIAL	0-10V	TTL	6-WIRE GROMMET
- BBD-JX	0-10V	DIFFERENTIAL	0-10V	24V	6-WIRE GROMMET
- DBB-JX	4-20mA	DIFFERENTIAL	0-10V	TTL	6-WIRE GROMMET
- DBDJX	4-20mA	DIFFERENTIAL	0-10V	24V	6-WIRE GROMMET

PPC5C

PPC34B

LCP35A

LCP45B

PPC47A

PPC400A









PPC92B

PPC93A

OPTIONS

STANDARD PLUG-IN - ELECTRICAL CONNECTIONS

PPC5C **XXX-XXXX-(XXX-XX)** - ELECTRICAL OPTIONS

	PART NO.	PIN	DESCRIPTION	MATING CORD
	- (CAA-AX)	3	1 COMMON 2 POWER +20.4 TO +26.4VDC 3 COMMAND	GREEN BLACK WHITE
	- (CAA-DX)	3 MICRO	1 COMMON 2 POWER +20.4 TO +26.4VDC 3 COMMAND	GREEN RED WITH BLACK TRACER RED WITH WHITE TRACER
	- (CBB-BX)	5 (SINGLE-ENDED)	1 + COMMAND 2 ANALOG MONITOR SIGNAL 3 COMMON 4 LOGIC MONITOR SIGNAL 5 POWER +20.4 TO +26.4VDC	WHITE RED GREEN ORANGE BLACK
	- (BBA-BX) - (BAB-BX) - (DBA-BX) - (DAB-BX)	5 (DIFFERENTIAL)	1 + COMMAND 2 - COMMAND 3 COMMON 4 IMS or AMS 5 POWER +20.4 TO +26.4VDC	WHITE RED GREEN ORANGE BLACK
	- (CBB-EX)	5 MICRO (SINGLE ENDED)	1 + COMMAND 2 ANALOG MONITOR 3 COMMON 4 LOGIC MONITOR SIGNAL 5 POWER +20.4 TO +26.4VDC	RED WITH WHITE TRACER RED GREEN RED WITH YELLOW TRACER RED WITH BLACK TRACER
	- (BBA-EX) - (BAB-EX) - (DBA-EX) - (DAB-EX)	5 MICRO (DIFFERENTIAL)	1 + COMMAND 2 - COMMAND 3 COMMON 4 IMS or AMS 5 POWER +20.4 TO +26.4VDC	RED WITH WHITE TRACER RED GREEN RED WITH YELLOW TRACER RED WITH BLACK TRACER
	- (BBB-CX) - (DBB-CX)	6	1 LOGIC MONITOR SIGNAL 2 - COMMAND 3 POWER +20.4 TO +26.4VDC 4 + COMMAND 5 ANALOG MONITOR SIGNAL 6 COMMON	ORANGE BLUE BLACK WHITE RED GREEN
	- (BBB-FX) - (DBB-FX)	6 MICRO	1 + COMMAND 2 ANALOG MONITOR SIGNAL 3 COMMON 4 LOGIC MONITOR SIGNAL 5 POWER +20.4 TO +26.4VDC 6 - COMMAND	RED WITH WHITE TRACER RED GREEN RED WITH YELLOW TRACER RED WITH BLACK TRACER RED WITH BLUE TRACER

STANDARD WIRE GROMMET - ELECTRICAL CONNECTIONS

PPC5C **XXX-XXXX-(XXX-XX)** - ELECTRICAL OPTIONS

PART NO.	WIRES	DESCRIPTION	WIRE COLOR
- (CAA-GX)	3	COMMON POWER +20.4 TO +26.4VDC COMMAND	GREEN RED WITH BLACK TRACER RED WITH WHITE TRACER
- (BAA-HX) - (DAA-HX)	4	COMMON POWER +20.4 TO +26.4VDC + COMMAND - COMMAND	GREEN RED WITH BLACK TRACER RED WITH WHITE TRACER RED WITH BLUE TRACER
- (CBB-IX)	5	COMMAND ANALOG MONITOR SIGNAL COMMON LOGIC MONITOR SIGNAL POWER +20.4 TO +26.4VDC	RED WITH WHITE TRACER RED GREEN RED WITH YELLOW TRACER RED WITH BLACK TRACER
- (BAB-IX) - (BBA-IX) - (DAB-IX) - (DBA-IX)	5	+ COMMAND - COMMAND COMMON IMS or AMS POWER +20.4 TO +26.4VDC	RED WITH WHITE TRACER RED GREEN RED WITH YELLOW TRACER RED WITH BLACK TRACER
- (BBB-JX) - (DBB-JX)	6	+ COMMAND ANALOG MONITOR SIGNAL COMMON LOGIC MONITOR SIGNAL POWER +20.4 TO +26.4VDC - COMMAND	RED WITH WHITE TRACER RED GREEN RED WITH YELLOW TRACER RED WITH BLACK TRACER RED WITH BLUE TRACER